

Accessories.



Model no. 106
Treeline

Model no. 108
Alder finish

ONLY for the following carcass colours:

- Semi-solid alder
- Semi-solid oak
- **NEW** for beech semi solid wood too



All measurements are approximate and in metric cm. We reserve the right to amend technical data and measurements.

Independent / non HDI
BLANK PRICE LIST
valid until **30.06.2023**



Schadstoff-
geprüft
Emissions-
geprüft

www.tuv.com
ID 0000045390



ATTENTION: When ordering accessories please indicate the desired interior design and the wardrobe code the accessories are ordered for!

Accessories.



Schadstoff-geprüft
Emissions-geprüft
www.tuv.com
ID 0000045390



Accessories.



Schadstoff-
geprüft
Emissions-
geprüft

www.tuv.com
ID 0000045390



Accessories.



Schadstoff-
geprüft
Emissions-
geprüft

www.tuv.com
ID 000045390



Accessories.



Schadstoff-
geprüft
Emissions-
geprüft

www.tuv.com
ID 000045390



Accessories.

Independent / non HDI

BLANK PRICE LIST





valid until 30.06.2023



Shelves

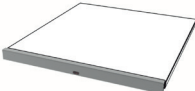

When ordering more than one accessory item for a compartment, please make sure that all accessories do not interfere with each other's function.

Description	Dimensions cm			Art. no.	GBP
	W	H	D		
1 shelf					
- for compartment width 47.5 cm	47,5	2,2	51,5	028	
- for compartment width 72.2 cm	72,3	2,2	51,5	234	
- for compartment width 80.1 cm	80,1	2,2	51,5	320 *	
- for compartment width 96.4 cm	96,4	2,2	51,5	030	
* ONLY for sliding door units !					
 3 shelves					
- for compartment width 47.5 cm	47,5	2,2	51,5	029	
- for compartment width 72.2 cm	72,3	2,2	51,5	027	
- for compartment width 80.1 cm	80,1	2,2	51,5	321 *	
- for compartment width 96.4 cm	96,4	2,2	51,5	031	
* ONLY for sliding door units !					
LED Light screen for shelves					
 - for compartment width 47.5 cm 1 item	47,5	3	1	190	
- for compartment width 72.2 cm 1 item	72,3	3	1	191	
- for compartment width 80.1 cm 1 item	80,1	3	1	199	
- for compartment width 96.4 cm 1 item	96,4	3	1	192	
- for compartment width 47.5 cm 2 items	47,5	3	1	193	
- for compartment width 72.2 cm 2 items	72,3	3	1	194	
- for compartment width 80.1 cm 2 items	80,1	3	1	200	
- for compartment width 96.4 cm 2 items	96,4	3	1	195	
- for compartment width 47.5 cm 3 items	47,5	3	1	196	
- for compartment width 72.2 cm 3 items	72,3	3	1	197	
- for compartment width 80.1 cm 3 items	80,1	3	1	201	
- for compartment width 96.4 cm 3 items	96,4	3	1	198	
This product contains a light device of energy efficiency class F					
Not useable in centre compartment for 2-doors Sliding-door wardrobes!					
					
					

Accessories.

Independent / non HDI

BLANK PRICE LIST





valid until 30.06.2023



Shelves

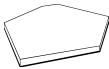

When ordering more than one accessory item for a compartment, please make sure that all accessories do not interfere with each other's function.

Description	Dimensions cm			Art. no.	GBP
	W	H	D		
 <p>1 adjustable shelf for extended corner unit</p>	88	2,2	88	420	
 <p>1 adjustable shelf for end unit, angled</p>	43	2,2	51,5	290	
 <p>1 adjustable shelf for laundry unit (W 93 cm)</p>	89	2,2	32	435	
 <p>1 adjustable shelf for overbed unit - in width:</p> <p>140 cm</p> <p>160 cm</p> <p>180 cm</p> <p>200 cm</p>	71	2,2	36	286 *	
	81	2,2	36	287 *	
	91	2,2	36	288 *	
	101	2,2	36	289 *	

** Only available in model no. 106 Treeline

Accessories.

Independent / non HDI

BLANK PRICE LIST









valid until 30.06.2023

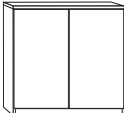

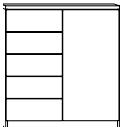
Shelves

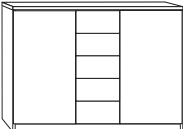

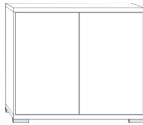
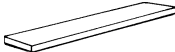
When ordering more than one accessory item for a compartment, please make sure that all accessories do not interfere with each other's function.

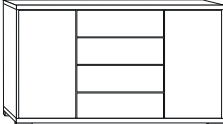
	Description	Dimensions cm			Art. no.	GBP
		W	H	D		
 Installation options: 	1 adjustable shelf for dresser with 2 doors (W 93 cm) Only for drawer units: W 93, H 89, D 37 cm	89	2,2	31	434	
 Installation options: 	1 adjustable shelf for combination dresser W 93 cm Only for drawer units: W 93, H 89, D 37 cm	44	2,2	32	245	
 Installation options: 	2 adjustable shelves for combination dresser W 125 cm Only for drawer units: W 125, H 89, D 37 cm	44	2,2	32	433	
 Installation options: 	1 adjustable shelf for dresser with 2 doors (W 93 cm) Only for drawer units: W 93, H 86, D 42 cm	90	2,2	37	436	
 Installation options: 	1 adjustable shelf for combi dresser, narrow Only for drawer units: W 93, H 86, D 42 cm	44	2,2	37	437	
 Installation options: 	2 adjustable shelves for combination dresser with 4 large drawers in centre, 2 doors outside Only for drawer units: W 149, H 86, D 42 cm	35	2,2	37	438	

Accessories.

Independent / non HDI

BLANK PRICE LIST



valid until 30.06.2023



Suspension fittings



When ordering more than one accessory item for a compartment, please make sure that all accessories do not interfere with each other's function.

Description	Dimensions cm			Art. no.	GBP
	W	H	D		
 <p>Hanging rail</p> <ul style="list-style-type: none"> - for compartment width 47.5 cm - for compartment width 72.2 cm - for compartment width 80.1 cm - for compartment width 96.4 cm <p>* ONLY for sliding door units !</p>	47,5	3	2	049	
	72,3	3	2	053	
	80,1	3	2	303*	
	96,4	3	2	050	
 <p>Clothes lift for compartment width 72.3 - 96.4 cm</p> <p>Maximum load 10 kg</p>	100	85	14	051	
 <p>Clothes carousel for extended corner unit</p>	60	169	10	058	

Accessories.

Independent / non HDI

BLANK PRICE LIST









valid until 30.06.2023

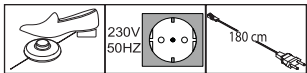

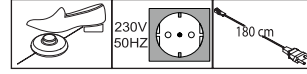
Lights

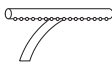
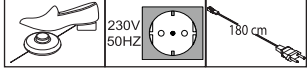

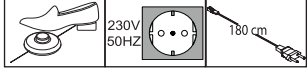
When ordering more than one accessory item for a compartment, please make sure that all accessories do not interfere with each other's function.

Description	Dimensions cm			Art. no.	GBP
	W	H	D		
 <p>LED line light</p> <p>1 item 2 items 3 items</p> <p>Dieses Produkt enthält eine Lichtquelle der Energieeffizienzklasse E</p> 	60	6	19	170	
	60	6	19	171	
	60	6	19	172	
 <p>LED Clip-On-Lights</p> <p>1 item 2 items 3 items</p> <p>Dieses Produkt enthält eine Lichtquelle der Energieeffizienzklasse E</p>  <p> Only in conjunction with PPT-Frame and cornice!</p>	60	1,5	4,5	173	
	60	1,5	4,5	174	
	60	1,5	4,5	175	
 <p>LED strip light</p> <p>1 item 2 items 3 items</p> <p>Dieses Produkt enthält eine Lichtquelle der Energieeffizienzklasse G</p> 	35	4	18	950	
	35	4	18	951	
	35	4	18	952	
 <p>Power LED light, chrome</p> <p>1 item 2 items 3 items</p> <p>Dieses Produkt enthält eine Lichtquelle der Energieeffizienzklasse F</p> 	5,5	3	22,5	732	
	5,5	3	22,5	733	
	5,5	3	22,5	734	
 <p>LED Wardrobe interior lights with motion detector, incl. rechargeable battery via USB</p> <p>1 item 2 items 3 items 4 items</p>	10	2	10	106	
	10	2	10	107	
	10	2	10	108	
	10	2	10	109	

Accessories.

Independent / non HDI

BLANK PRICE LIST



valid until 30.06.2023



Additional fittings

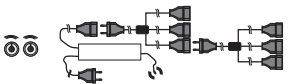
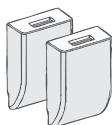

When ordering more than one accessory item for a compartment, please make sure that all accessories do not interfere with each other's function.

Description	Dimensions cm			Art. no.	GBP
	W	H	D		
 <p>Radio receiver for lighting with 2 transmitters; for connection to up to 5 loads</p>	40	9	13	009	
 <p>USB adaptor, to charge USB equipment (incl. transformer, extension cable 1.8 m), 2.1 ampere output line</p> <p>pair</p> 	3	4,5	1,4	035	

Accessories.

Independent / non HDI

BLANK PRICE LIST

valid until 30.06.2023



Interior partitioning

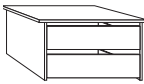
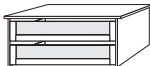
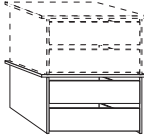

When ordering more than one accessory item for a compartment, please make sure that all accessories do not interfere with each other's function.

Description	Dimensions cm			Art. no.	GBP
	W	H	D		
 <p>Drawer insert with 2 drawers and wooden front for hinged- and sliding-door wardrobes</p> <ul style="list-style-type: none"> - for 50 cm compartment width of drawer insert: 32.5 cm - for 75 cm compartment Width of drawer insert: 57.3 cm - for 80 cm compartment Width of drawer insert: 65.1 cm - for 100 cm compartment Width of drawer insert: 81.4 cm <p>* ONLY for sliding door units !</p>					
 <p>Drawer insert with 2 drawers and glass front for hinged- and sliding-door wardrobes</p> <ul style="list-style-type: none"> - for 50 cm compartment width of drawer insert: 32.5 cm - for 75 cm compartment Width of drawer insert: 57.3 cm - for 80 cm compartment Width of drawer insert: 65.1 cm - for 100 cm compartment Width of drawer insert: 81.4 cm <p>* ONLY for sliding door units !</p>					
 <p>Drawer insert with 2 drawers and wooden front for hinged- and sliding-door wardrobes, stackable and height adjustable</p> <ul style="list-style-type: none"> - for compartment width 47.5 cm - for compartment width 72.2 cm - for compartment width 80.1 cm - for compartment width 96.4 cm <p>* Not available in alder finish!</p>					

Accessories.

Independent / non HDI

BLANK PRICE LIST







valid until 30.06.2023

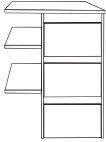

Interior partitioning

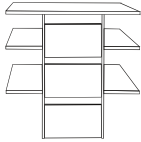
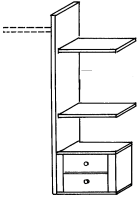

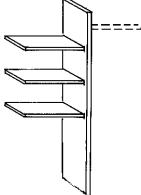
When ordering more than one accessory item for a compartment, please make sure that all accessories do not interfere with each other's function.

	Description	Dimensions cm			Art. no.	GBP
		W	H	D		
	Drawer insert with 3 drawers and wooden front - for compartment width 72.2 cm - for compartment width 80.1 cm Drawers can be mounted left/right!	72,3 80,1	89 89	51,5 51,5	110 112	
	 Not suitable for 280cm wide sliding-door wardrobe!					
	Drawer insert with 3 drawers and wooden front - for compartment width 96.4 cm	96,4	89	51,5	111	
	Laundry shelf insert, consisting of: 2 drawers, 2 shelves, 1 hanging rail, 1 mid panel - for compartment width 72.2 cm - for compartment width 96.4 cm For use on both sides (left or right)!	72,3 96,4	137 137	51,5 51,5	253 251	
 Only to be placed on base plinth!						
	Laundry shelf insert, consisting of: 3 shelves, 1 hanging rail, 1 mid panel - for compartment width 72.2 cm - for compartment width 80.1 cm - for compartment width 96.4 cm For use on both sides (left or right)!	72,3 80,1 96,4	137 137 137	51,5 51,5 51,5	252 254 250	
 Only to be placed on base plinth!						

Accessories.

Independent / non HDI

BLANK PRICE LIST



valid until 30.06.2023



Interior partitioning

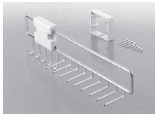
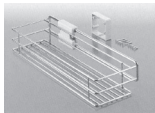
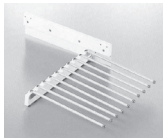

When ordering more than one accessory item for a compartment, please make sure that all accessories do not interfere with each other's function.

Description	Dimensions cm			Art. no.	GBP
	W	H	D		
 <p>Tie and belt rack</p>	30	27	9	040	
 <p>Tie and belt pull-out</p>	7	19	45	059	
 <p>Utensil pull-out</p>	16	9	45	476	
 <p>Trouser holder</p>	45	10	50	056	
 <p>Shoe rack for unit compartment W 96.4 cm</p>	96	15	50	055	

Accessories.

Independent / non HDI

BLANK PRICE LIST

valid until 30.06.2023



Interior partitioning

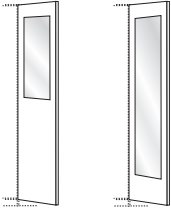
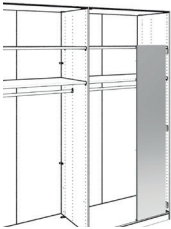

When ordering more than one accessory item for a compartment, please make sure that all accessories do not interfere with each other's function.

Description	Dimensions cm			Art. no.	GBP
	W	H	D		
 <p>Interior mirror</p> <p>! ATTENTION ! Only in combination with swing doors!</p> <p>* Not suitable for solid wood doors!</p> <p>Art. no. 046 Art. no. 079</p>	36 36	80 173	1 1	046 079*	
 <p>Fold-out interior mirror</p> <p>! ATTENTION ! Only in conjunction with sliding-door wardrobes! Not for use in conjunction with LED light screens!</p>	36	173	1	080	