

# Split.

# V.i.P.

by Wiemann



Independent / non HDI  
**BLANK PRICE LIST**  
 valid

01.03.2023-31.08.2023



Emissionsgeprüft  
 Schadstoffgeprüft  
 Regelmäßige  
 Produkt-  
 überwachung

www.tuv.com  
 ID 1111253053



## Carcase and front colours

Please specify the exact colour combination of front and carcase colour for each order!

### Designs:

Carcase and front

**Modell-Nr. 894**  
**Pebble grey finish**

**Model no. 896**  
**Graphite**

**Handle ledges in graphite**

**Handle ledges in black**

**Handles in black**

**Handles in black**

Highlight colour

**Transparent black  
glass with diamond  
looks**

Interior colour

**Silver grey  
striped**

Mirror

**Crystal mirror**

## Quality details

- HDF back walls
- Doors open up to 105° and cushioned hinges
- 22mm shelves on metal shelf supports
- Metal hanging rails on metal supports, carry up to 60kg
- All fittings are made of metal and highly resistant
- Maximum comfort by delivery of pre-assembled occasional furniture

Independent / non HDI  
**BLANK PRICE LIST**  
valid 01.03.2023-31.08.2023



Emissionsgeprüft  
Schadstoffgeprüft  
Regelmäßige  
Produkt-  
überwachung  
[www.tuv.com](http://www.tuv.com)  
ID 1111253053



**Split.****V.i.P.**  
by Wiemann**Carcase width****Hinged-door wardrobes**

	Side	Plinth	Side	Plinth	Side	Plinth	Side	Plinth	Side	Width effective
50	1,5	47,5	1,5							50,5 cm
100	1,5	96,4	1,5							99,4 cm
150	1,5	96,4	1,5	47,5	1,5					148,4 cm
150	1,5	47,5	1,5	47,5	1,5	47,5	1,5			148,5 cm
200	1,5	47,5	1,5	96,4	1,5	47,5	1,5			197,4 cm
200	1,5	96,4	1,5	96,4	1,5					197,3 cm
250	1,5	47,5	1,5	72,2	1,5	72,2	1,5	47,5	1,5	246,9 cm
250	1,5	96,4	1,5	96,4	1,5	47,5	1,5			246,3 cm
300	1,5	47,5	1,5	96,4	1,5	96,4	1,5	47,5	1,5	295,3 cm
300	1,5	96,4	1,5	96,4	1,5	96,4	1,5			295,2 cm
350	1,5	96,4	1,5	96,4	1,5	47,5	1,5	96,4	1,5	344,2 cm
400	1,5	96,4	1,5	96,4	1,5	96,4	1,5	96,4	1,5	393,1 cm

**Sliding door wardrobes**

	Side	Plinth	Side	Plinth	Side	Plinth	Side	Plinth	Side	Width effective
200	1,5	96,4	1,5	96,4	1,5					197,3 cm
250	1,5	72,2	1,5	47,5	1,5	47,5	1,5	72,2	1,5	246,9 cm
300	1,5	72,2	1,5	72,2	1,5	72,2	1,5	72,2	1,5	296,3 cm

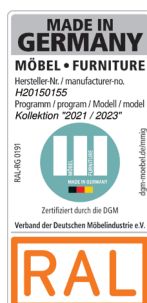

We reserve the right to color and model deviations or the correction of erroneous information. All measures are approximate cm.

# Split.

# V.i.P.

by Wiemann



Independent / non HDI  
**BLANK PRICE LIST**  
valid

01.03.2023-31.08.2023



Emissionsgeprüft  
Schadstoffgeprüft  
Regelmäßige  
Produkt-  
überwachung

www.tuv.com  
ID 1111253053



We reserve the right to color and model deviations or the correction of erroneous information. All measures are approximate cm.

**Split.**

**V.i.P.**  
by Wiemann



Independent / non HDI  
**BLANK PRICE LIST**  
valid 01.03.2023-31.08.2023



Emissionsgeprüft  
Schadstoffgeprüft  
Regelmäßige  
Produkt-  
überwachung  
[www.tuv.com](http://www.tuv.com)  
ID 1111253053



We reserve the right to color and model deviations or the correction of erroneous information. All measures are approximate cm.

# Split.

# V.i.P. by Wiemann



Independent / non HDI  
**BLANK PRICE LIST**  
valid

01.03.2023-31.08.2023



Emissionsgeprüft  
Schadstoffgeprüft  
Regelmäßige  
Produkt-  
überwachung

www.tuv.com  
ID 1111253053



We reserve the right to color and model deviations or the correction of erroneous information. All measures are approximate cm.

**Split.**

Independent / non HDI

**BLANK PRICE LIST**

valid

01.03.2023-31.08.2023

**V.i.P.**  
by Wiemann**Hinged-door wardrobes**  
without cornice, handles in black**Interior:**

2 shelves, 1 clothes rail per compartment

All hinged-doors incl. cushioned hinges

Description	Dimensions		Height 216 cm		Height 236 cm	
	W	D	Art. no.	GBP	Art. no.	GBP
 <p><b>Outside doors in carcase colour, centre door/s with surrounding in graphite in transparent black glass with diamond looks</b></p>	3 doors	1 Glass door 50 cm	150	58	<b>412</b>	<b>430</b>
	4 doors	2 Glass doors each 50 cm	200	58	<b>413</b>	<b>436</b>
	6 doors	4 Glass doors each 37,5 cm	250	58	<b>415</b>	<b>437</b>
	6 doors	4 Glass doors each 50 cm	300	58	<b>417</b>	<b>439</b>
	7 doors	3 Glass doors each 50 cm	350	58	<b>420</b>	<b>441</b>
	8 doors	4 Glass doors each 50 cm	400	58	<b>423</b>	<b>443</b>

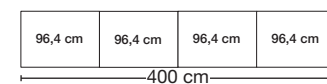
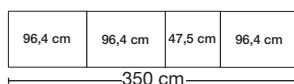
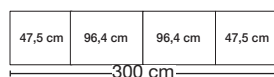
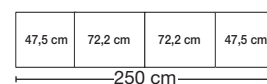
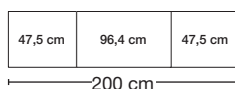
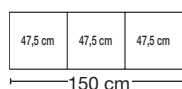
**Plinth partition**

**Split.**

Independent / non HDI

**BLANK PRICE LIST**

valid

01.03.2023-31.08.2023

**V.i.P.**  
by Wiemann**Hinged-door wardrobes  
without cornice, handles in black****Interior:**

2 shelves, 1 clothes rail per compartment





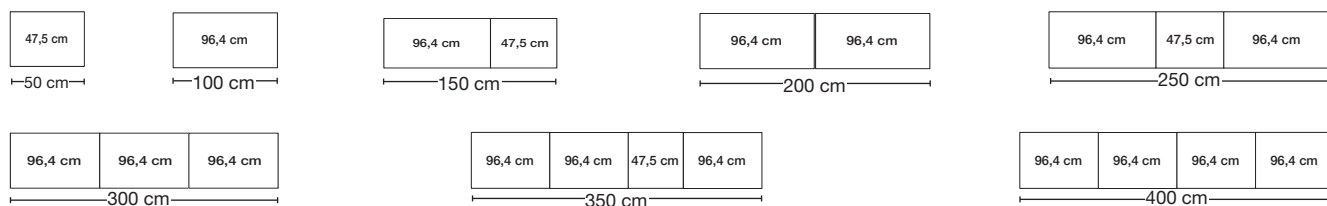

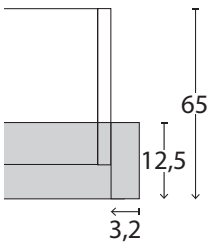

All hinged-doors incl. cushioned hinges

Description	Dimensions		Height 216 cm		Height 236 cm	
	W	D	Art. no.	GBP	Art. no.	GBP
 <p>door surrounding in graphite with transparent black glass with diamond looks</p>	1 door	LHH	50	58	<b>500</b>	<b>515</b>
	1 door	RHH	50	58	<b>501</b>	<b>516</b>
	2 doors		100	58	<b>502</b>	<b>517</b>
	3 doors		150	58	<b>503</b>	<b>518</b>
	4 doors		200	58	<b>504</b>	<b>519</b>
	5 doors		250	58	<b>505</b>	<b>520</b>
	6 doors		300	58	<b>506</b>	<b>521</b>
	7 doors		350	58	<b>507</b>	<b>522</b>
	8 doors		400	58	<b>508</b>	<b>523</b>

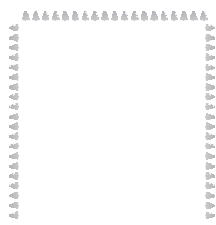
**Plinth partition**



## Passe-partout frames for hinged-door wardrobes with or without lights

Description	Dimensions		Height 220 cm		Height 240 cm	
	W	D	Art. no.	GBP	Art. no.	GBP
 <p><b>Passe-partout frame, without lights</b> Width per side profile: 3.2 cm</p> <ul style="list-style-type: none"> <li>- for width 50 cm</li> <li>- for width 100 cm</li> <li>- for width 150 cm</li> <li>- for width 200 cm</li> </ul> <p>Top view wardrobe incl. PPT-Frame</p>  <p>Dimensions cm</p>	56,4	12,5	<b>900</b>		<b>913</b>	
	106,4	12,5	<b>901</b>		<b>914</b>	
	156,4	12,5	<b>902</b>		<b>915</b>	
	206,4	12,5	<b>904</b>		<b>917</b>	
	256,4	12,5	<b>906</b>		<b>919</b>	
	 - only for 5-doors wardrobes					
	256,4	12,5	<b>907</b>		<b>920</b>	
	 - only for 6-doors wardrobes					
	306,4	12,5	<b>908</b>		<b>921</b>	
	356,4	12,5	<b>910</b>		<b>923</b>	
	406,4	12,5	<b>912</b>		<b>925</b>	
	 <p><b>Surcharge for circumferential LED illumination (optional):</b></p> <ul style="list-style-type: none"> <li>- for width 50 cm</li> <li>- for width 100 cm</li> <li>- for width 150 cm</li> <li>- for width 200 cm</li> </ul>	56,4	12,5	<b>926</b>		<b>939</b>
106,4		12,5	<b>927</b>		<b>940</b>	
156,4		12,5	<b>928</b>		<b>941</b>	
206,4		12,5	<b>930</b>		<b>943</b>	
256,4		12,5	<b>932</b>		<b>945</b>	
 - only for 5-doors wardrobes						
256,4		12,5	<b>933</b>		<b>946</b>	
 - only for 6-doors wardrobes						
306,4		12,5	<b>934</b>		<b>947</b>	
356,4		12,5	<b>936</b>		<b>949</b>	
406,4	12,5	<b>938</b>		<b>981</b>		
<p>This product contains light devices of energy efficiency class F</p>   						



**Please note:**

Passe-partout frame increases the wardrobe width to the dimensions indicated.

## Passe-partout frames for hinged-door wardrobes with lights

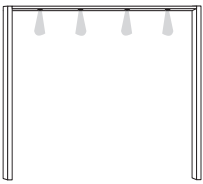
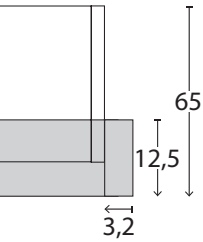
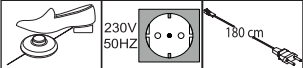
Description	Dimensions		Height 220 cm		Height 240 cm	
	W	D	Art. no.	GBP	Art. no.	GBP
 <p><b>Passe-partout frame, with lights,</b> Width per side profile: 3.2 cm</p> <p>1 light - for width 50 cm 2 lights - for width 100 cm 3 lights - for width 150 cm 4 lights - for width 200 cm</p> <p><b>Top view wardrobe incl. PPT-Frame</b></p>  <p>Dimensions cm</p> <p>5 lights - for width 250 cm <b>⚠ - only for 5-doors wardrobes</b></p> <p>6 lights - for width 250 cm <b>⚠ - only for 6-doors wardrobes</b></p> <p>6 lights - for width 300 cm 7 lights - for width 350 cm 8 lights - for width 400 cm</p> <p>This product contains light devices of energy efficiency class</p> 	56,4	12,5	<b>P01</b>		<b>P14</b>	
	106,4	12,5	<b>P02</b>		<b>P15</b>	
	156,4	12,5	<b>P03</b>		<b>P16</b>	
	206,4	12,5	<b>P05</b>		<b>P18</b>	
	256,4	12,5	<b>P07</b>		<b>P20</b>	
	256,4	12,5	<b>P08</b>		<b>P21</b>	
	306,4	12,5	<b>P09</b>		<b>P22</b>	
	356,4	12,5	<b>P11</b>		<b>P24</b>	
	406,4	12,5	<b>P13</b>		<b>P26</b>	

**Split.**



Independent / non HDI

**BLANK PRICE LIST**

valid

01.03.2023-31.08.2023

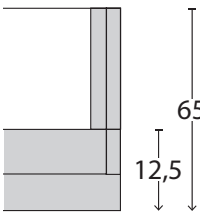
**V.i.P.**  
by Wiemann**Cornices**  
with or without lights

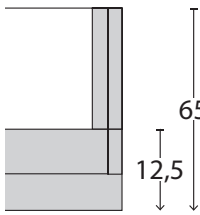
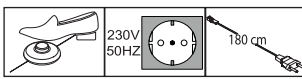
	Description	Dimensions cm			Art. no.	GBP
		W	H	D		
 <p><b>Cornice,</b> without lights</p> <p>- for width 50 cm - for width 100 cm - for width 150 cm - for width 200 cm</p> <p><b>Top view wardrobe incl. cornice</b></p>  <p>Dimensions cm</p> <p>- for width 250 cm ⚠ - only for 5-doors wardrobes - for width 250 cm ⚠ - only for 6-doors wardrobes</p> <p>- for width 300 cm - for width 350 cm - for width 400 cm</p>						
		56,4	3,2	12,5	<b>950</b>	
		106,4	3,2	12,5	<b>951</b>	
		156,4	3,2	12,5	<b>952</b>	
		206,4	3,2	12,5	<b>954</b>	
		256,4	3,2	12,5	<b>956</b>	
		256,4	3,2	12,5	<b>957</b>	
		306,4	3,2	12,5	<b>958</b>	
		356,4	3,2	12,5	<b>960</b>	
		406,4	3,2	12,5	<b>962</b>	
 <p><b>With LED lights</b></p> <p>1 light - for width 50 cm 2 lights - for width 100 cm 3 lights - for width 150 cm 4 lights - for width 200 cm</p> <p><b>Top view wardrobe incl. cornice</b></p>  <p>Dimensions cm</p> <p>5 lights - for width 250 cm ⚠ - only for 5-doors wardrobes 6 lights - for width 250 cm ⚠ - only for 6-doors wardrobes</p> <p>6 lights - for width 300 cm 7 lights - for width 350 cm 8 lights - for width 400 cm</p>						
		56,4	3,2	12,5	<b>963</b>	
		106,4	3,2	12,5	<b>964</b>	
		156,4	3,2	12,5	<b>965</b>	
		206,4	3,2	12,5	<b>967</b>	
		256,4	3,2	12,5	<b>969</b>	
		256,4	3,2	12,5	<b>970</b>	
		306,4	3,2	12,5	<b>971</b>	
		356,4	3,2	12,5	<b>973</b>	
		406,4	3,2	12,5	<b>975</b>	
<p>This product contains light devices of energy efficiency class</p> 						

**Split.**

Independent / non HDI

**BLANK PRICE LIST**

valid

01.03.2023-31.08.2023

**V.i.P.**  
by Wiemann

**Sliding door wardrobes**  
without cornice

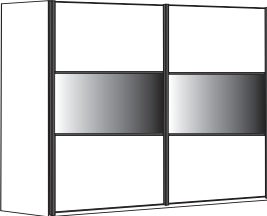
Description	Dimensions		Height 217 cm		Height 236 cm	
	W	D	Art. no.	GBP	Art. no.	GBP
 <p>Front in carcass colour, middle panels in transparent black glass with diamond looks and surrounding in graphite</p>	200	67	<b>724</b>		<b>737</b>	
	250	67	<b>725</b>		<b>738</b>	
	300	67	<b>700</b>		<b>739</b>	

**Plinth partition**

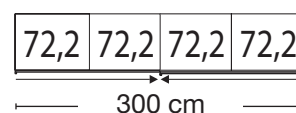
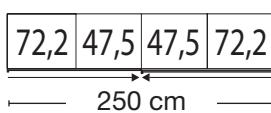
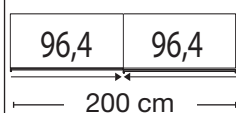

**Split.**

Independent / non HDI

**BLANK PRICE LIST**

valid

01.03.2023-31.08.2023

**V.i.P.**  
by Wiemann**Passe-partout frames for sliding door wardrobes**  
with or without lights

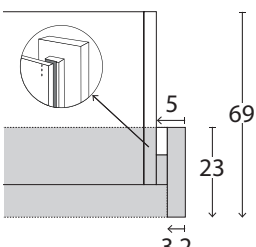
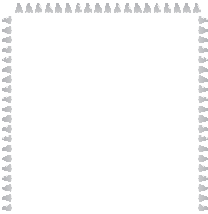
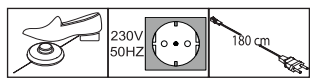
Description	Dimensions		Height 221 cm		Height 240 cm	
	W	D	Art. no.	GBP	Art. no.	GBP
 <p><b>Without lights, Width per side profile 5 cm</b></p> <ul style="list-style-type: none"> <li>- for width 200 cm</li> <li>- for width 250 cm</li> <li>- for width 300 cm</li> </ul> <p><b>Top view wardrobe incl. PPT-Frame</b></p>  <p>Dimensions cm</p>	210	23	<b>800</b>		<b>806</b>	
	260	23	<b>801</b>		<b>807</b>	
	310	23	<b>802</b>		<b>808</b>	
 <p><b>Surcharge for circumferential LED illumination (optional):</b></p> <ul style="list-style-type: none"> <li>- for width 200 cm</li> <li>- for width 250 cm</li> <li>- for width 300 cm</li> </ul> <p>This product contains light devices of energy efficiency class F</p> 	210	23	<b>803</b>		<b>809</b>	
	260	23	<b>804</b>		<b>810</b>	
	310	23	<b>805</b>		<b>811</b>	

**Split.**





Independent / non HDI

**BLANK PRICE LIST**

valid

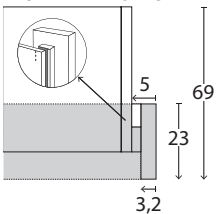
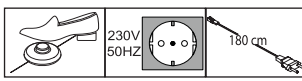
01.03.2023-31.08.2023

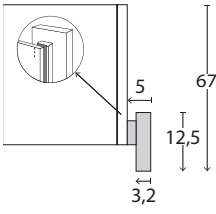
**V.i.P.**  
by Wiemann**Passe-partout frames for sliding door wardrobes  
with lights**

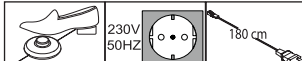
Description	Dimensions		Height 221 cm		Height 240 cm	
	W	D	Art. no.	GBP	Art. no.	GBP
 <p><b>With LED lights,</b> Width per side profile 5 cm</p> <p>4 lights - for width 200 cm 4 lights - for width 250 cm 6 lights - for width 300 cm</p> <p><b>Top view wardrobe incl. PPT-Frame</b></p> 	210	23	<b>976</b>		<b>979</b>	
	260	23	<b>977</b>		<b>816</b>	
	310	23	<b>978</b>		<b>817</b>	
<p><b>Dimensions cm</b></p> <p>This product contains light devices of energy efficiency class</p> 						
 <p><b>Side profiles in carcass colour, pair</b></p>	5	12,5	<b>098</b>		<b>099</b>	
<p><b>Top view wardrobe incl. PPT-Frame</b></p> 						
 <p><b>Lights for side profiles</b></p> <p><b>Can not get assembled retrospectively!</b></p> <p><b>Useabl for side profiles and PPT-Frame without circumferential lights!</b></p> <p>This product contains light devices of energy efficiency class F</p> 	1,5	1	<b>096</b>		<b>101</b>	

**Split.**



Independent / non HDI

**BLANK PRICE LIST**

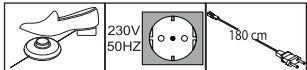

valid

01.03.2023-31.08.2023

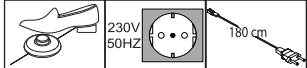
**V.i.P.**  
by Wiemann**Unit accessories**

Description	Dimensions cm			Art. no.	GBP
	W	H	D		
 <p><b>LED Clip-On-Lights, black</b></p> <p>1 item 2 items 3 items</p> <p>This product contains light devices of energy efficiency class</p>  <p><b>Only in conjunction with PPT-Frame and cornice!</b></p>	60	6	19	<b>880</b>	
	60	6	19	<b>881</b>	
	60	6	19	<b>882</b>	
 <p><b>LED line light, black</b></p> <p>1 item 2 items 3 items</p> <p>This product contains light devices of energy efficiency class</p> 	60	6	19	<b>883</b>	
	60	6	19	<b>884</b>	
	60	6	19	<b>885</b>	

**Additional elements  
for sliding door wardrobes**

Description	Dimensions cm			Art. no.	GBP
	W	H	D		
 <p><b>Bumper</b></p> <p>- for 2-doors wardrobes      1 item</p> <p> <b>Optimal functioning only in combination with self-closing mechanism for outer doors</b></p>	28	4	2	<b>366</b>	
 <p><b>2-piece set self-closing mechanism with buffering for outside doors</b></p> <p>pair</p>	24	2	11	<b>365</b>	

## Unit accessories

Interior finish: silver grey striped

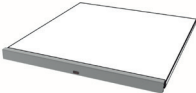
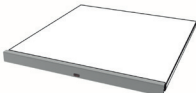
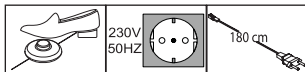
Description	Dimensions cm			Art. no.	GBP
	W	H	D		
 <p><b>LED light screen for shelves behind wooden doors (sensor control)</b></p> <p>- for compartment width 47.5 cm 1 item - for compartment width 72.2 cm 1 item - for compartment width 96.4 cm 1 item</p> <p>- for compartment width 47.5 cm 2 items - for compartment width 72.2 cm 2 items - for compartment width 96.4 cm 2 items</p> <p>- for compartment width 47.5 cm 3 items - for compartment width 72.2 cm 3 items - for compartment width 96.4 cm 3 items</p> <p>This product contains a light device of energy efficiency class</p>	47,5	3	1	<b>010</b>	
	72,2	3	1	<b>002</b>	
	96,4	3	1	<b>011</b>	
	47,5	3	1	<b>019</b>	
	72,2	3	1	<b>003</b>	
	96,4	3	1	<b>013</b>	
	47,5	3	1	<b>014</b>	
	72,2	3	1	<b>004</b>	
	96,4	3	1	<b>015</b>	
	 <p><b>LED Light screen for shelves behind glass doors as permanent light with foot pedal</b></p> <p>- for compartment width 47.5 cm 1 item - for compartment width 96.4 cm 1 item</p> <p>- for compartment width 72.2 cm 2 items - for compartment width 96.4 cm 2 items</p> <p>- for compartment width 96.4 cm 3 items</p> <p>- for compartment width 72.2 cm 4 items - for compartment width 96.4 cm 4 items</p> <p>This product contains light devices of energy efficiency class G</p> 	47,5	3	1	<b>181</b>
96,4		3	1	<b>183</b>	
72,2		3	1	<b>185</b>	
96,4		3	1	<b>186</b>	
96,4		3	1	<b>193</b>	
72,2		3	1	<b>191</b>	
72,2		3	1	<b>192</b>	



**Split.**

Independent / non HDI





**BLANK PRICE LIST**

valid

01.03.2023-31.08.2023

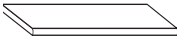
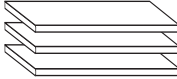
**V.i.P.**  
by Wiemann**Unit accessories**

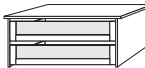
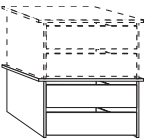
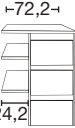
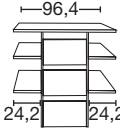
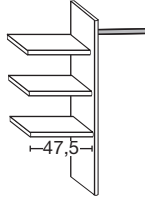
Interior finish: silver grey striped

	Description	Dimensions cm			Art. no.	GBP
		W	H	D		
	<b>1 shelf</b> - for compartment width 47.5 cm 1 item - for compartment width 72.2 cm 1 item - for compartment width 96.4 cm 1 item	47,5 72,2 96,4	2,2 2,2 2,2	51,5 51,5 51,5	<b>035</b> <b>036</b> <b>030</b>	
	<b>3 shelves</b> - for compartment width 47.5 cm 3 items - for compartment width 72.2 cm 3 items - for compartment width 96.4 cm 3 items	47,5 72,2 96,4	2,2 2,2 2,2	51,5 51,5 51,5	<b>037</b> <b>038</b> <b>031</b>	
	<b>Hanging rail</b> - for compartment width 47.5 cm 1 item - for compartment width 72.2 cm 1 item - for compartment width 96.4 cm 1 item	47,5 72,2 96,4	3 3 3	2 2 2	<b>049</b> <b>052</b> <b>050</b>	
	<b>Drawer insert with 2 drawers and glass front for hinged- and sliding-door wardrobes</b> - for compartment width 72.2 cm - for compartment width 96.4 cm	72,2 96,4	41 41	52 52	<b>068</b> <b>070</b>	
	<b>Drawer insert with 2 drawers and wooden front for hinged- and sliding-door wardrobes, stackable and height adjustable</b> - for compartment width 72.2 cm - for compartment width 96.4 cm	72,2 96,4	41 41	44 44	<b>071</b> <b>073</b>	
  Art. no. 023      Art. no. 064	<b>Drawer insert with 3 drawers and wooden front</b> - for compartment width 72.2 cm - for compartment width 96.4 cm	72,2 96,4	89 89	51,5 51,5	<b>023</b> <b>064</b>	
	<b>Laundry shelf insert, consisting of:</b> 3 adjustable shelves, 1 hanging rail, 1 mid panel - for compartment width 72.2 cm - for compartment width 96.4 cm	72,2 96,4	137 137	51,5 51,5	<b>025</b> <b>066</b>	
	<b>For use on both sides (left or right)!</b> <b>Only to be placed on base plinth!</b>					

**Split.**

Independent / non HDI





**BLANK PRICE LIST**

valid

01.03.2023-31.08.2023

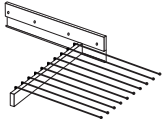
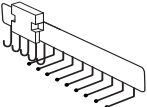
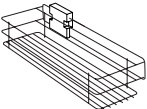
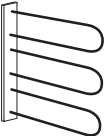
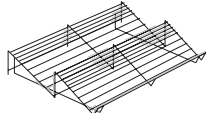
**V.i.P.**  
by Wiemann**Unit accessories**

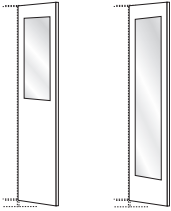
Interior finish: silver grey striped

Description	Dimensions cm			Art. no.	GBP
	W	H	D		
 <p><b>Trousers holder</b></p>	45	10	50	<b>056</b>	
 <p><b>Tie and belt pull-out</b></p>	7	19	45	<b>059</b>	
 <p><b>Utensil pull-out</b></p>	16	9	45	<b>076</b>	
 <p><b>Tie and belt rack</b></p>	30	27	9	<b>042</b>	
 <p><b>Shoe rack</b> for unit compartment W 96.4 cm</p>	96	15	50	<b>093</b>	
 <p><b>Clothes lift</b> for compartment width 72,3 - 96,4 cm</p>	100	85	14	<b>081</b>	
 <p><b>Interior mirror</b></p> <p> <b>Not for use in conjunction with sliding-door wardrobes!</b> <b>Not for use in conjunction with glass doors!</b></p> <p>Art. no.    Art. no. 046        047</p>	36 36	80 173	1 1	<b>046</b> <b>047</b>	

**Split.**

Independent / non HDI

**BLANK PRICE LIST**



valid

01.03.2023-31.08.2023

**V.i.P.**  
by Wiemann**Futon beds**

Footboard height: 48 cm

4-position height adjustment

Description	Bed surface in cm	Surface in cm	Art. no.	GBP
 <p><b>Feet and side braces in the headboard in black</b></p> <p> <b>Not available in pebble grey finish!</b></p> <p>Headboard height: <b>97</b> cm Footboard height: <b>48</b> cm Height to bed side top edge: <b>48</b> cm</p>	140 x 190	149 x 199	<b>660</b>	
	150 x 200	159 x 209	<b>200</b>	
	160 x 200	169 x 209	<b>665</b>	
	180 x 200	189 x 209	<b>669</b>	

**Additional elements**

for futon beds

Description	Dimensions cm			Art. no.	GBP
	W	H	D		
 <p><b>Slatted bases</b></p> <p>- for bed 140 x 190 cm</p> <p>- for bed 150 x 200 cm</p> <p>- for bed 160 x 200 cm</p> <p>- for bed 180 x 200 cm</p>	140	8	190	<b>106 330</b>	
	150	8	200	<b>106 340</b>	
	160	8	200	<b>106 350</b>	
	180	8	200	<b>106 360</b>	

**Split.**

Independent / non HDI





**BLANK PRICE LIST**

valid

01.03.2023-31.08.2023

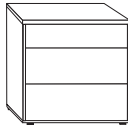
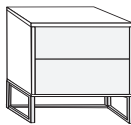

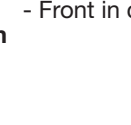

**V.i.P.**  
by Wiemann**Bedside cabinets**

Depth 43 cm, Handles in black

			Height 48 cm		Height 47 cm	
Description		Width in cm	Sliding feet in black Art. no.	GBP	Angled feet in black Art. no.	GBP
 	- Front in carcass colour	40	<b>A01</b>		<b>A05</b>	
	 <b>Width 40 cm</b>	40	<b>A02</b>		<b>A06</b>	
 	- Front in carcass colour	60	<b>A03</b>		<b>A07</b>	
	 <b>Width 60 cm</b>	60	<b>A04</b>		<b>A08</b>	

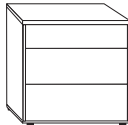
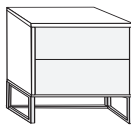
**Bedside cabinets**

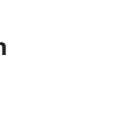
Depth 43 cm

			Height 63 cm		Height 61 cm	
Description		Width in cm	Sliding feet in black Art. no.	GBP	Angled feet in black Art. no.	GBP
 	- Front in carcass colour	40	<b>A09</b>		<b>A13</b>	
	 <b>Width 40 cm</b>	40	<b>A10</b>		<b>A14</b>	
 	- Front in carcass colour	60	<b>A11</b>		<b>A15</b>	
	 <b>Width 60 cm</b>	60	<b>A12</b>		<b>A16</b>	

**Split.**

Independent / non HDI

**BLANK PRICE LIST**

valid

01.03.2023-31.08.2023

**V.i.P.**  
by Wiemann**Panels**  
for bedside cabinets

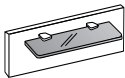
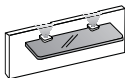
Description	Dimensions cm			Art. no.	GBP
	W	H	D		
 <p><b>Beside cabinet panel, with smoked glass shelf</b></p>	piece	40	20	12	<b>B01</b>
	pair	40	20	12	<b>B02</b>
	piece	60	20	12	<b>B03</b>
	pair	60	20	12	<b>B04</b>
 <p><b>Beside cabinet panel, with smoked glass shelf and LED lights</b></p>	piece	40	20	12	<b>B05</b>
	pair	40	20	12	<b>B06</b>
	piece	60	20	12	<b>B07</b>
	pair	60	20	12	<b>B08</b>
<p>This product contains light devices of energy efficiency class</p>					

**Split.**

Independent / non HDI

**BLANK PRICE LIST**

valid

01.03.2023-31.08.2023

**V.i.P.**  
by Wiemann

All hinged-doors incl. cushioned hinges





**Occasional furniture**

Handles in black

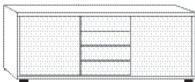

Depth 43 cm

Height 70 cm

H 89 cm

Description	Width in cm	Sliding feet in black		Art. no.	GBP
		Art. no.	GBP		
 <b>Dresser, 2 doors, with one full-width shelf</b>	80	<b>B80</b>		<b>B86</b>	
 <b>Chest of drawers, 4 drawers</b>	60	<b>B81</b>		<b>B87</b>	
	 - Front in carcass colour	80	<b>B82</b>		<b>B88</b>
- Front in carcass colour	141	<b>B83</b>		<b>B89</b>	
 <b>Combi dresser, 4 drawers in centre, 2 outer doors with 1 shelf behind</b>	141	<b>B84</b>		<b>B90</b>	
 <b>Combi dresser, 4 drawers, 1 door with one adjustable shelf behind</b>	120	<b>B85</b>		<b>B91</b>	

**Interior accessories for occasional furniture**

Description	Dimensions cm			Art. no.	GBP
	W	H	D		
 <b>1 shelf</b> for 2 door chest	77	1,8	37,5	<b>C05</b>	
 <b>1 shelf</b> for combi dresser	37	1,8	37,5	<b>C06</b>	

**Split.**

Independent / non HDI



**BLANK PRICE LIST**

valid

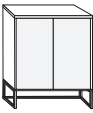

**01.03.2023-31.08.2023****V.i.P.**  
by Wiemann**Occasional furniture**

Handles in black

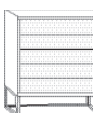
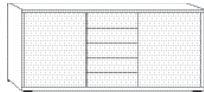
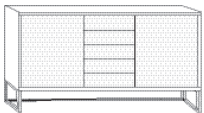
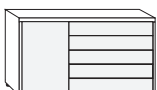
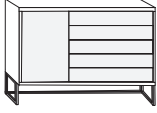
All hinged-doors incl. cushioned hinges

Description		Depth 43 cm	Height 86 cm		Height 105 cm	
			Width in cm	Sliding feet in black Art. no.	GBP	Art. no.
	<b>Dresser, 2 doors, with one full-width shelf</b>					
	- Front in carcass colour	80	<b>B92</b>		<b>B98</b>	
	<b>Chest of drawers, 5 drawers</b>					
	- Front in carcass colour	60	<b>B93</b>		<b>B99</b>	
	- Front in carcass colour	80	<b>B94</b>		<b>C01</b>	
	- Front in carcass colour	141	<b>B95</b>		<b>C02</b>	
	<b>Combination dresser, 5 pull-outs in centre, 2 outside doors, 1 adjustable shelf per door compartment</b>					
	- Front in carcass colour	141	<b>B96</b>		<b>C03</b>	
	<b>Combi dresser, 5 drawers, 1 door with one adjustable shelf behind</b>					
	- Front in carcass colour	120	<b>B97</b>		<b>C04</b>	

**Interior accessories for occasional furniture**

Description	Dimensions cm			Art. no.	GBP
	W	H	D		
 <b>1 shelf</b> for 2 door chest	77	1,8	37,5	<b>C05</b>	
 <b>1 shelf</b> for combi dresser	37	1,8	37,5	<b>C06</b>	

**Split.**



Independent / non HDI

**BLANK PRICE LIST**

valid

01.03.2023-31.08.2023

**V.i.P.**  
by Wiemann**Occasional furniture**

Description	Dimensions cm			Art. no.	GBP
	W	H	D		
 <b>Wall mirror, lateral or vertical mounting</b>	110	85	3	<b>086</b>	
 <b>Wall mirror</b>	60	80	3	<b>087</b>	