

Monaco 5000.

V.i.P.

by Wiemann



Independent / non HDI
BLANK PRICE LIST
 valid until 28.02.2025



Emissionsgeprüft
 Schadstoffgeprüft
 Regelmäßige
 Produkt-
 überwachung

www.tuv.com
 ID 1111253053



Monaco 5000.

V.i.P.
by Wiemann

CARCASE DESIGNS

Please state the exact colour combination with every order!

Designs:

Model no. 760
Bianco oak
finish

Model no. 761
White

Model no. 791
Pebble grey finish

Model no. 792
Champagne finish

Model no. 762
Graphite

Interior colour

Silver grey striped

furnplan



Emissionsgeprüft
Schadstoffgeprüft
Regelmäßige
Produkt-
überwachung

www.tuv.com
ID 1111253053

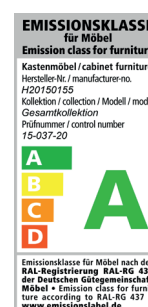

Monaco 5000.

V.i.P.
by Wiemann

Basic and add-on elements (can be customised)

Planning information Monaco 5000

1. Please always enclose a positioning sketch/furnishing plan with the order.
2. Always plan from the corner to the sides.
3. Components of a planning robe in the Monaco range are:
 - 1) One basic element (with 2 outer sides)
 - 2) Any number of add-on units (with 1 centre partition)



Note: Furnplan automatically differentiates between basic and add-on elements for planning wardrobes!

4. A planning or basic element is required directly next to a corner unit, shelf unit or end unit.

Examples:

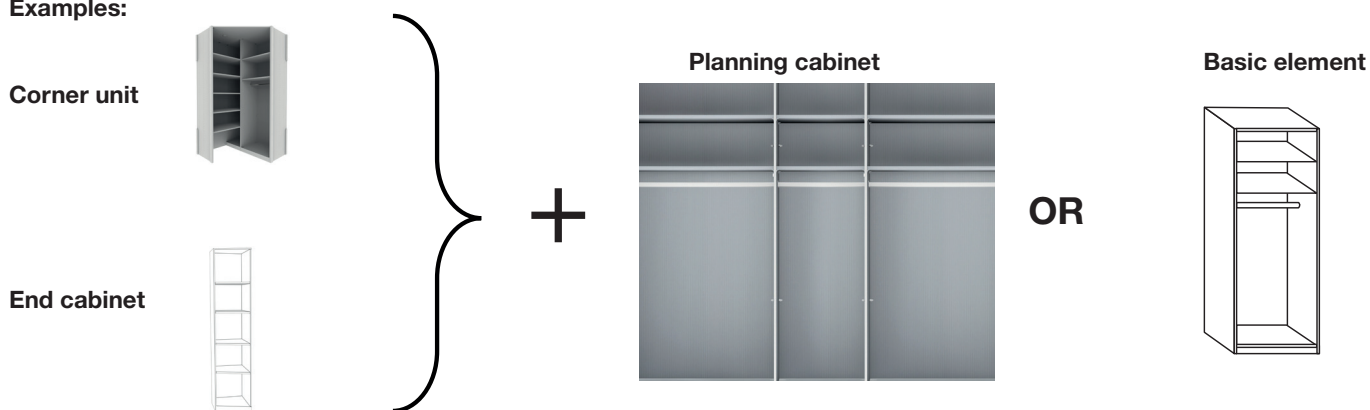

5. Cornice optionally with or without lights:

- 1) Please order the cornice for corner units or end units separately according to the type plan.
- 2) Please order the cornice for planning robes with art. no. KR1 or KR2.



Note: The cornice for planning wardrobes are supplied in one piece up to a maximum length of 300 cm!

Note: In the case of a combination of a planning wardrobe and a shelf unit, please order the cornice via art. no. KR1 or KR2!

Example 1:

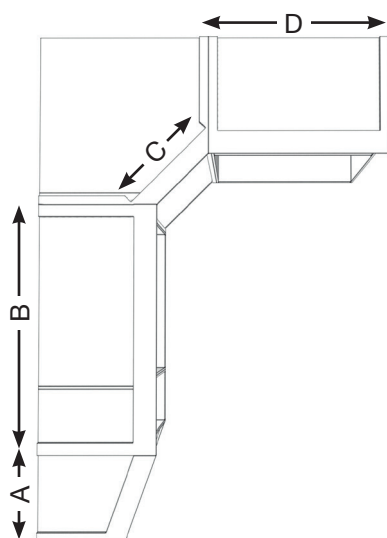

Element	Description	Article number cornice
A	End cabinet left	943
B	Planning cabinet, consisting of: 100cm basic element 37.5cm add-on element = total width 137.5cm	KR1 Price = 2 x KR1 (137.5cm is rounded up to 2m)
C	Extended corner unit	940
D	100cm robe	928

Monaco 5000.

V.i.P.
by Wiemann

Example 2:

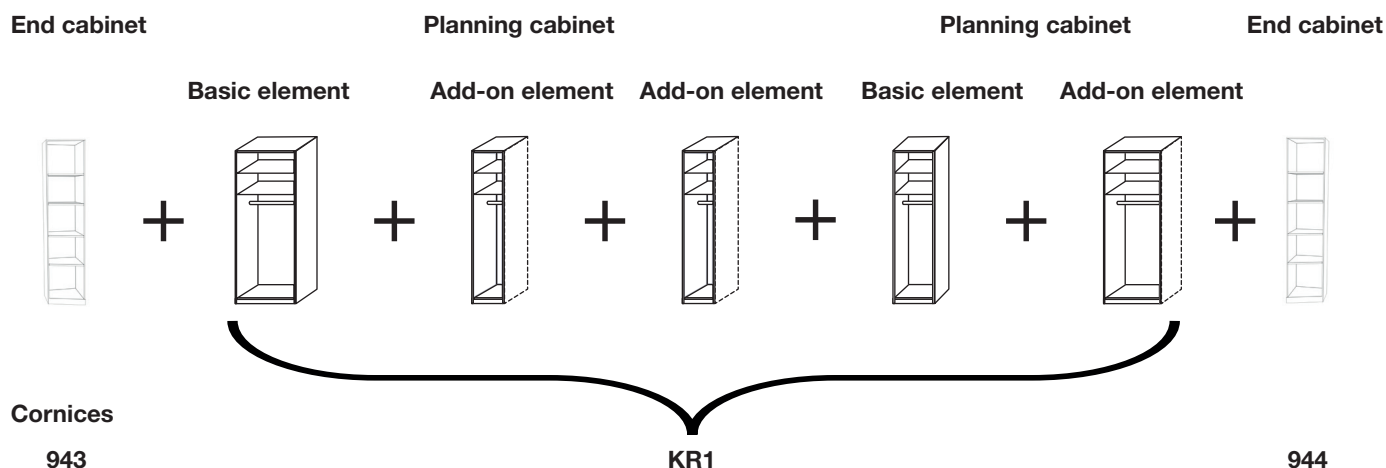

Planning examples Monaco 5000

1. Example - robe W 200 cm with cornice and lights:

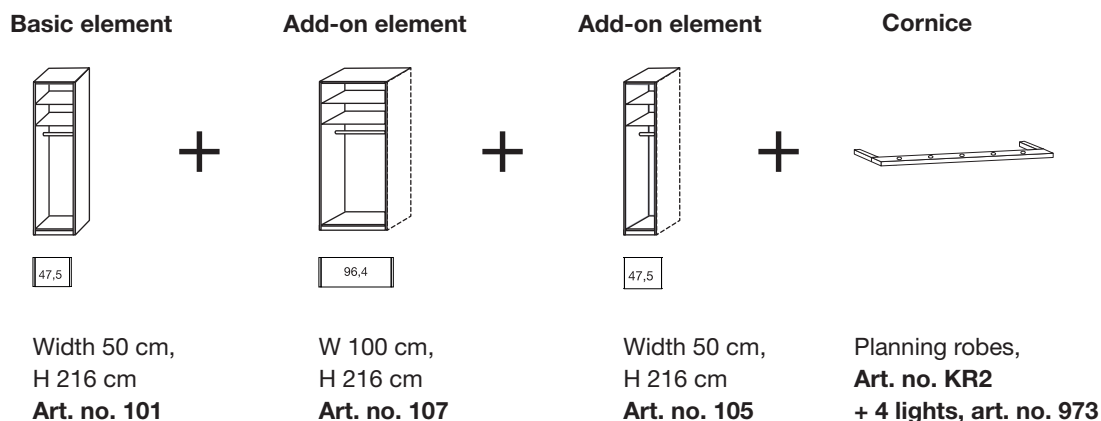

2. Example - robe W 288 cm without cornice:

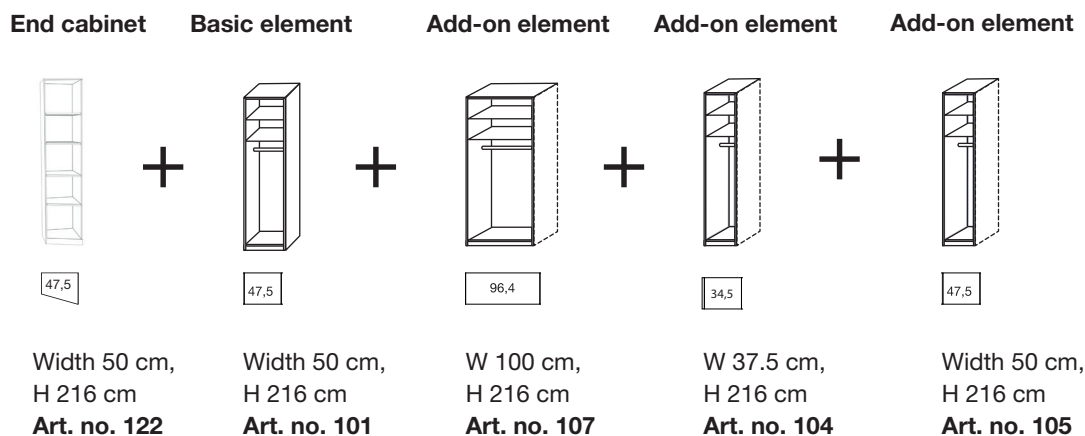

Monaco 5000.

V.i.P.
by Wiemann

3. Example - Corner combination with cornice without lights:

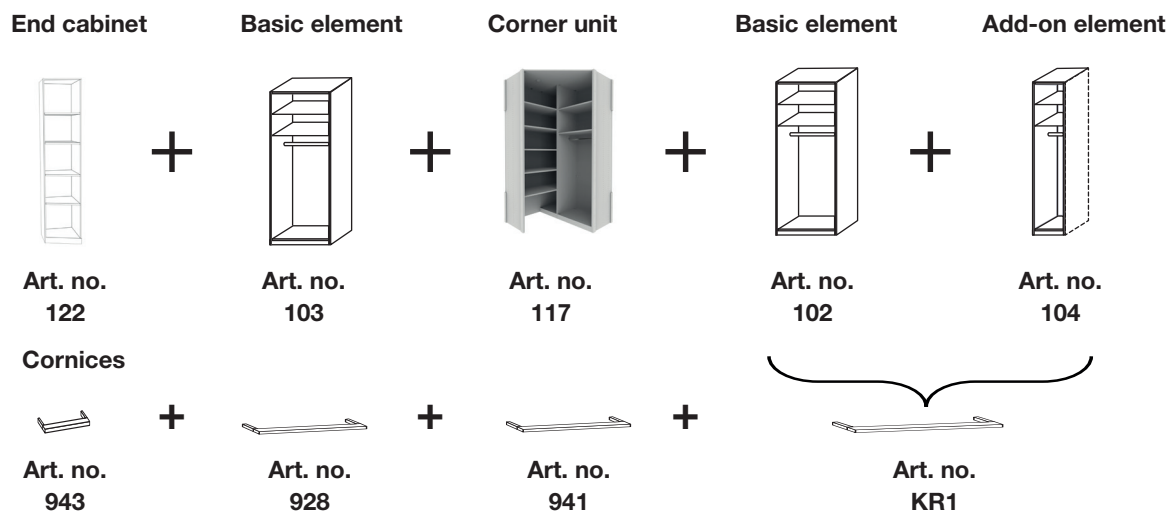

Monaco 5000.

V.i.P.
by Wiemann

Carcase width

Robes

Width	Side	Plinth	Side	Plinth	Side	Plinth	Side	Plinth	Side	Width effective
37,5	1,5	34,5	1,5							37,5 cm
50	1,5	47,5	1,5							50,5 cm
75	1,5	72,2	1,5							75,2 cm
100	1,5	96,4	1,5							99,4 cm
150	1,5	96,4	1,5	47,5	1,5					148,4 cm
150	1,5	72,2	1,5	72,2	1,5					148,9 cm
200	1,5	96,4	1,5	96,4	1,5					197,3 cm
225	1,5	72,2	1,5	72,2	1,5	72,2	1,5			222,6 cm
250	1,5	96,4	1,5	47,5	1,5	96,4	1,5			246,3 cm
250	1,5	47,5	1,5	72,2	1,5	72,2	1,5	47,5	1,5	246,9 cm
300	1,5	96,4	1,5	96,4	1,5	96,4	1,5			295,2 cm
300	1,5	72,2	1,5	72,2	1,5	72,2	1,5	72,2	1,5	296,3 cm
350	1,5	96,4	1,5	96,4	1,5	47,5	1,5	96,4	1,5	344,2 cm



Passepartout frames available for each free standing wardrobe (not connected with others)!

Monaco 5000.

Independent / non HDI

BLANK PRICE LIST

valid until 28.02.2025

V.i.P.

by Wiemann

Basic and add-on elements without cornice

Interior:
2 adjustable shelves, 1 clothes rail

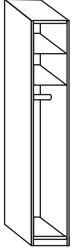
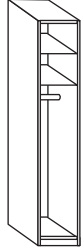
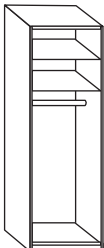
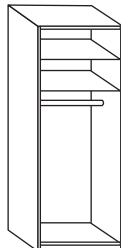
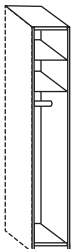
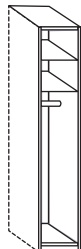
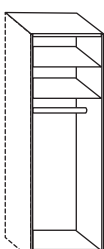
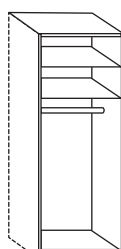
Description	Dimensions		Height 216 cm		Height 236 cm	
	W	D	Art. no.	GBP	Art. no.	GBP
Basic elements						
  Art. no. 100 / 108 Art. no. 101 / 109	37,5	56	100		108	
	50	56	101		109	
	75	56	102		110	
	100	56	103		111	
  Art. no. 102 / 110 Art. no. 103 / 111						
Add-on elements						
  Art. no. 104 / 112 Art. no. 105 / 113	37,5	56	104		112	
	50	56	105		113	
	75	56	106		114	
	100	56	107		115	
  Art. no. 106 / 114 Art. no. 107 / 115						

Plinth partition



Monaco 5000.

Independent / non HDI

BLANK PRICE LIST



valid until 28.02.2025

V.i.P.
by Wiemann

Corner units without cornice

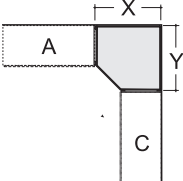

Not for use in conjunction with passe-partout frames!

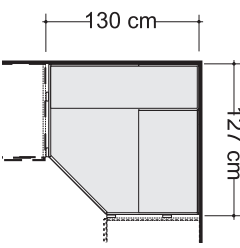
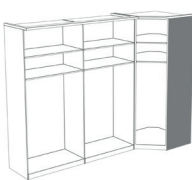
Description	Dimensions		Height 216 cm		Height 236 cm	
	W	D	Art. no.	GBP	Art. no.	GBP
 <p>Extended corner unit</p>  <p>X = 93,3 cm Y = 93,3 cm</p> <p>Interior: 2 shelves, 1 clothes rail per compartment</p>	93	93	116		119	
 <p>Walk-in corner unit</p>  <p>Interior: W 72.2cm: 2 shelves, 1 hanging rail, W 125 cm: 5 shelves, Lights with motion detector</p> <p><small>This product contains a light device of energy efficiency class G</small></p>	93	93	117		120	
 <p>End panel for corner unit, can be used on both sides (left and right)</p> <p>Required with a final extended corner unit. If a corner unit stands separately, 2 outer sides are required.</p>	56	1,5	090		091	

Monaco 5000.

Independent / non HDI



BLANK PRICE LIST

valid until 28.02.2025

V.i.P.
by Wiemann

End units without cornice

Interior:
4 adjustable shelves

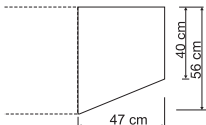
Description	Dimensions		Height 216 cm		Height 236 cm	
	W	D	Art. no.	GBP	Art. no.	GBP
 <p>Adjustable on the left</p> 	47	56	122		124	
 <p>Adjustable on the right</p> 	47	56	123		125	

**Not useable for standing alone!****Not for use in conjunction with passe-partout frames!****Attachment to extended corner unit only possible in combination with end panel!**

Monaco 5000.







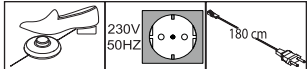

Independent / non HDI

BLANK PRICE LIST

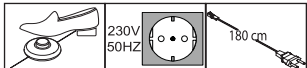
valid until 28.02.2025

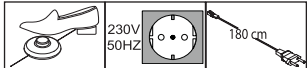
V.i.P.
by Wiemann

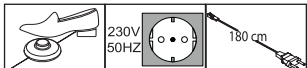
Unit accessories

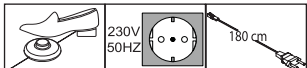
Description	Dimensions cm			Art. no.	GBP
	W	H	D		
 <p>LED Clip-On-Lights, silver</p> <p>1 item 2 items 3 items</p> <p>This product contains light devices of energy efficiency class E</p>  <p> Only in conjunction with PPT-Frame and cornice!</p>	60	1,5	4,5	980	
	60	1,5	4,5	981	
	60	1,5	4,5	982	
 <p>LED line light, silver</p> <p>1 item 2 items 3 items</p> <p>This product contains light devices of energy efficiency class E</p> 	60	6	19	983	
	60	6	19	984	
	60	6	19	985	
 <p>LED Clip-On-Lights, black</p> <p>1 item 2 items 3 items</p> <p>This product contains light devices of energy efficiency class E</p>  <p> Only in conjunction with PPT-Frame and cornice!</p>	60	1,5	4,5	880	
	60	1,5	4,5	881	
	60	1,5	4,5	882	
 <p>LED line light, black</p> <p>1 item 2 items 3 items</p> <p>This product contains light devices of energy efficiency class E</p> 	60	6	19	883	
	60	6	19	884	
	60	6	19	885	
 <p>LED top light, chrome</p> <p>1 item 2 items 3 items</p> <p>This product contains light devices of energy efficiency class F</p> 	5,5	3	22,5	794	
	5,5	3	22,5	795	
	5,5	3	22,5	796	

Monaco 5000.

Independent / non HDI

BLANK PRICE LIST

valid until 28.02.2025

V.i.P.

by Wiemann

Passe-partout frames without lights



Please note:

Passe-partout frame increases the wardrobe width to the dimensions indicated.

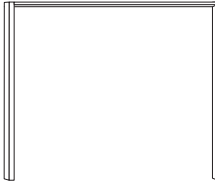
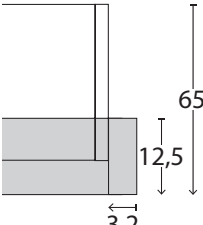
Description	Dimensions		Height 220 cm		Height 240 cm		
	W	D	Art. no.	GBP	Art. no.	GBP	
 <p>Width per side profiles: 3.2 cm, without lights</p> <ul style="list-style-type: none"> - for width 50 cm - for width 75 cm - for width 100 cm 	56,4	12,5	842		856		
	81,4	12,5	843		857		
	106,4	12,5	844		858		
	- for width 150 cm	156,4	12,5	845		859	
	- For plinth partitioning only 96,4 + 47,5 cm						
	- for width 150 cm	156,4	12,5	846		860	
	- For plinth partitioning only 72,2 + 72,2 cm						
	- for width 200 cm	206,4	12,5	847		861	
	- for width 225 cm	231,4	12,5	848		862	
	- for width 250 cm	256,4	12,5	849		863	
	- For plinth partitioning only 96,4 + 47,5 + 96,4 cm						
	- for width 250 cm	256,4	12,5	850		864	
	- For plinth partitioning only 72,2 + 72,2 + 72,2 cm						
	- for width 300 cm	306,4	12,5	851		865	
- For plinth partitioning only 96,4 + 96,4 + 96,4 cm							
- for width 300 cm	306,4	12,5	852		866		
- For plinth partitioning only 72,2 + 72,2 + 72,2 + 72,2 cm							
- for width 350 cm	356,4	12,5	853		867		
<p>Top view wardrobe incl. PPT-Frame</p>  <p>Dimensions cm</p>							

Monaco 5000.

Independent / non HDI

BLANK PRICE LIST

valid until 28.02.2025

V.i.P.

by Wiemann

Circumferential LED illumination (optional)

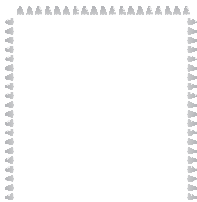

Can not get assembled retrospectively!

Description	Dimensions		Height 220 cm		Height 240 cm	
	W	D	Art. no.	GBP	Art. no.	GBP
 <p>Surcharge for circumferential LED illumination (optional):</p>						
- for width 100 cm	106,4	12,5	873		887	
- for width 150 cm - For plinth partitioning only 96,4 + 47,5 cm	156,4	12,5	874		888	
- for width 150 cm - For plinth partitioning only 72,2 + 72,2 cm	156,4	12,5	868		869	
- for width 200 cm - for width 225 cm	206,4 231,4	12,5 12,5	875 876		889 890	
- for width 250 cm - For plinth partitioning only 96,4 + 47,5 + 96,4 cm	256,4	12,5	877		891	
- for width 250 cm - For plinth partitioning only 72,2 + 72,2 + 72,2 cm	256,4	12,5	878		892	
- for width 300 cm - For plinth partitioning only 96,4 + 96,4 + 96,4 cm	306,4	12,5	879		893	
- for width 300 cm - For plinth partitioning only 72,2 + 72,2 + 72,2 + 72,2 cm	306,4	12,5	986		894	
- for width 350 cm	356,4	12,5	987		895	

This product contains light devices
of energy efficiency class F

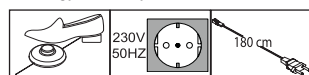

Monaco 5000.

Independent / non HDI

BLANK PRICE LIST

valid until 28.02.2025

V.i.P.

by Wiemann

Passe-partout frames with LED lights



Please note:

Passe-partout frame increases the wardrobe width to the dimensions indicated.

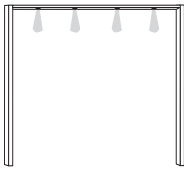
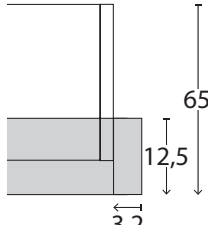
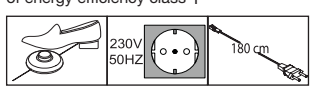
Description	Dimensions		Height 220 cm		Height 240 cm	
	W	D	Art. no.	GBP	Art. no.	GBP
 <p>Width per side profiles: 3.2 cm, with LED lights</p> <p>1 light - for width 50 cm 2 lights - for width 75 cm 3 lights - for width 100 cm</p> <p>3 lights - for width 150 cm - For plinth partitioning only 96,4 + 47,5 cm</p> <p>4 lights - for width 150 cm - For plinth partitioning only 72,2 + 72,2 cm</p> <p>4 lights - for width 200 cm 6 lights - for width 225 cm</p> <p>5 lights - for width 250 cm - For plinth partitioning only 96,4 + 47,5 + 96,4 cm</p> <p>6 lights - for width 250 cm - For plinth partitioning only 72,2 + 72,2 + 72,2 cm</p> <p>6 lights - for width 300 cm - For plinth partitioning only 96,4 + 96,4 + 96,4 cm</p> <p>8 lights - for width 300 cm - For plinth partitioning only 72,2 + 72,2 + 72,2 + 72,2 cm</p> <p>7 lights - for width 350 cm</p>	56,4	12,5	898		912	
	81,4	12,5	899		913	
	106,4	12,5	900		914	
	156,4	12,5	901		915	
	156,4	12,5	902		916	
	206,4	12,5	903		917	
	231,4	12,5	904		918	
	256,4	12,5	905		919	
	256,4	12,5	906		920	
	306,4	12,5	907		921	
306,4	12,5	908		922		
356,4	12,5	909		923		
<p>Top view wardrobe incl. PPT-Frame</p>  <p>Dimensions cm</p> <p>This product contains light devices of energy efficiency class F</p> 						

Monaco 5000.

Independent / non HDI

BLANK PRICE LIST

valid until 28.02.2025

V.i.P.
by Wiemann

Cornices without lights

Description	Dimensions cm			Art. no.	GBP
	W	H	D		
 <ul style="list-style-type: none"> - for width 37,5 cm - for width 50 cm - for width 75 cm - for width 100 cm 	37,5	3,2	12,5	964	
	50	3,2	12,5	926	
	75	3,2	12,5	927	
	100	3,2	12,5	928	
<ul style="list-style-type: none"> - for width 150 cm - For plinth partitioning only 96,4 + 47,5 cm 	150	3,2	12,5	929	
<ul style="list-style-type: none"> - for width 150 cm - For plinth partitioning only 72,2 + 72,2 cm 	150	3,2	12,5	930	
<ul style="list-style-type: none"> - for width 200 cm - for width 225 cm 	200	3,2	12,5	931	
	225	3,2	12,5	932	
<ul style="list-style-type: none"> - for width 250 cm - For plinth partitioning only 96,4 + 47,5 + 96,4 cm 	250	3,2	12,5	933	
<ul style="list-style-type: none"> - for width 250 cm - For plinth partitioning only 72,2 + 72,2 + 72,2 cm 	250	3,2	12,5	934	
<ul style="list-style-type: none"> - for width 300 cm - For plinth partitioning only 96,4 + 96,4 + 96,4 cm 	300	3,2	12,5	935	
<ul style="list-style-type: none"> - for width 300 cm - For plinth partitioning only 72,2 + 72,2 + 72,2 + 72,2 cm 	300	3,2	12,5	936	
<ul style="list-style-type: none"> - for width 350 cm 	350	3,2	12,5	937	
For corner units: <ul style="list-style-type: none"> - for extended corner unit - for walk-in corner unit 	65	3,2	12,5	940	
	114	3,2	12,5	941	
For end units: <ul style="list-style-type: none"> - for end unit left - for end unit right 	55,5	3,2	12,5	943	
	55,5	3,2	12,5	944	

Monaco 5000.

Independent / non HDI

BLANK PRICE LIST

valid until 28.02.2025

V.i.P.

by Wiemann

Cornices

for LED lights, the light is not included and has to be ordered separately

Description	Dimensions cm			Art. no.	GBP
	W	H	D		
 <ul style="list-style-type: none"> - for width 37,5 cm 1 drill - for width 50 cm 1 drill - for width 75 cm 2 drills - for width 100 cm 2 drills 	37,5	3,2	12,5	966	
	50	3,2	12,5	946	
	75	3,2	12,5	947	
	100	3,2	12,5	948	
<ul style="list-style-type: none"> - for width 150 cm 3 drills - For plinth partitioning only 96,4 + 47,5 cm 	150	3,2	12,5	949	
<ul style="list-style-type: none"> - for width 150 cm 4 drills - For plinth partitioning only 72,2 + 72,2 cm 	150	3,2	12,5	950	
<ul style="list-style-type: none"> - for width 200 cm 4 drills - for width 225 cm 6 drills 	200	3,2	12,5	951	
	225	3,2	12,5	952	
<ul style="list-style-type: none"> - for width 250 cm 5 drills - For plinth partitioning only 96,4 + 47,5 + 96,4 cm 	250	3,2	12,5	953	
<ul style="list-style-type: none"> - for width 250 cm 6 drills - For plinth partitioning only 72,2 + 72,2 + 72,2 cm 	250	3,2	12,5	954	
<ul style="list-style-type: none"> - for width 300 cm 6 drills - For plinth partitioning only 96,4 + 96,4 + 96,4 cm 	300	3,2	12,5	955	
<ul style="list-style-type: none"> - for width 300 cm 8 drills - For plinth partitioning only 72,2 + 72,2 + 72,2 + 72,2 cm 	300	3,2	12,5	956	
<ul style="list-style-type: none"> - for width 350 cm 7 drills 	350	3,2	12,5	957	

Monaco 5000.

Independent / non HDI

BLANK PRICE LIST

valid until 28.02.2025

V.i.P.

by Wiemann

Cornices

for LED lights, the light is not included and has to be ordered separately

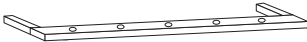
Description	Dimensions cm			Art. no.	GBP
	W	H	D		
 For corner units: - for extended corner unit 1 drill - for walk-in corner unit 2 drills	65	3,2	12,5	958	
	114	3,2	12,5	959	
For end units: - for end unit left 1 drill - for end unit right 1 drill	55,5	3,2	12,5	961	
	55,5	3,2	12,5	962	

Lights kit for cornices

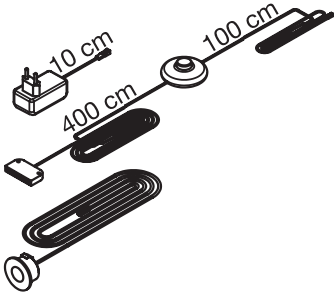
Description	Dimensions cm			Art. no.	GBP	
	W	H	D			
LED light kit consisting of: Foot switch, LED plug with supply cable and LED spot(s)						
 <p>Maximum distance between outer spotlights:</p>	1 light	–	1	1	1	970
	2 lights	360 cm	1	1	1	971
	3 lights	360 cm	1	1	1	972
	4 lights	360 cm	1	1	1	973
	5 lights	500 cm	1	1	1	974
	6 lights	500 cm	1	1	1	975
	7 lights	500 cm	1	1	1	976
	8 lights	500 cm	1	1	1	977
	9 lights	680 cm	1	1	1	978
	10 lights	680 cm	1	1	1	979

This product contains light devices of energy efficiency class F



Monaco 5000.

Independent / non HDI

BLANK PRICE LIST

valid until 28.02.2025

V.i.P.
by Wiemann

Cornice for wardrobes, consisting of basic and add-on elements

without lights



Description	Dimensions cm			Art. no.	GBP
	W	H	D		
 Cornice, without lights	1	3,2	12,5	KR1	Price per running metre
Important notes on ordering the cornice: This cornice is exclusively for planning elements, consisting of basic and add-on elements, can be ordered. The price is calculated as follows: The individual element widths are added together, resulting in the total length of the cornice. This is rounded up to full metres and with the price of article number KR1 multiplied. Attention: The article number KR1 must be used regardless of the length of the wreath, can only be ordered once! Note: The cornice for planning wardrobes are supplied in one piece up to a maximum length of 300 cm! Note: In the case of a combination of a planning wardrobe and a shelf unit, the cornice has to be ordered via art. no. KR1 or KR2!					

Order example:

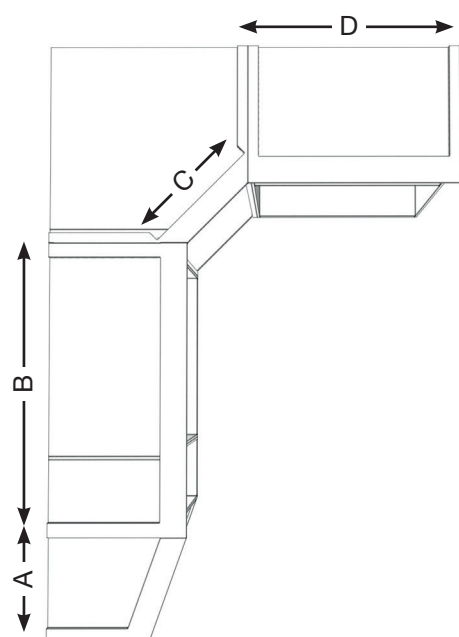

Element	Description	Article number cornice
A	End cabinet left	943
B	Planning cabinet, consisting of: 100cm basic element 37.5cm add-on element = total width 137.5cm	KR1 Price = 2 x KR1 (137.5cm is rounded up to 2m)
C	Extended corner unit	940
D	100cm robe	928

Monaco 5000.

Independent / non HDI

BLANK PRICE LIST

valid until 28.02.2025

V.i.P.
by Wiemann

Cornice for wardrobes, consisting of basic and add-on elements with lights

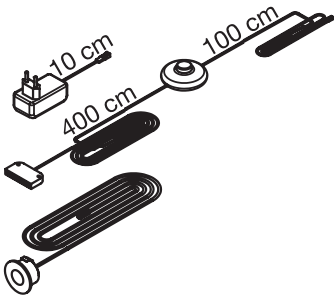
Description	Dimensions cm			Art. no.	GBP
	W	H	D		
 <p>Cornice, for LED lights, the light is not included and has to be ordered separately</p>	1	3,2	12,5	KR2	Price per running metre
<p>Important notes on ordering the cornice:</p> <p>This cornice is exclusively for planning elements, consisting of basic and add-on elements, can be ordered.</p> <p>The price is calculated as follows: The individual element widths are added together, resulting in the total length of the cornice. This is rounded up to full metres and with the price of article number KR2 multiplied.</p> <p>Attention: The article number KR2 must be used regardless of the length of the wreath, can only be ordered once!</p>					
<p>LED light kit consisting of: Foot switch, LED plug with supply cable and LED spot(s)</p> 	<p>Maximum distance between outer spotlights:</p>				
1 light	–			970	
2 lights	360 cm			971	
3 lights	360 cm			972	
4 lights	360 cm			973	
5 lights	500 cm			974	
6 lights	500 cm			975	
7 lights	500 cm			976	
8 lights	500 cm			977	
9 lights	680 cm			978	
10 lights	680 cm			979	

This product contains light devices of energy efficiency class F



Monaco 5000.

Independent / non HDI







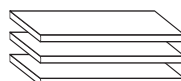

BLANK PRICE LIST

valid until 28.02.2025

V.i.P.
by Wiemann

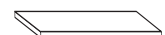
Unit accessories

Interior finish: silver grey striped

Description	Dimensions cm			Art. no.	GBP
	W	H	D		
 <p>1 shelf</p> <ul style="list-style-type: none"> - for compartment width 34,5 cm 1 item - for compartment width 47.5 cm 1 item - for compartment width 72.2 cm 1 item - for compartment width 96.4 cm 1 item 	34,5	2,2	51,5	026	
	47,5	2,2	51,5	028	
	72,2	2,2	51,5	036	
	96,4	2,2	51,5	030	
 <p>3 shelves</p> <ul style="list-style-type: none"> - for compartment width 34,5 cm 3 items - for compartment width 47.5 cm 3 items - for compartment width 72.2 cm 3 items - for compartment width 96.4 cm 3 items 	34,5	2,2	51,5	027	
	47,5	2,2	51,5	029	
	72,2	2,2	51,5	038	
	96,4	2,2	51,5	031	
 <p>1 adjustable shelf for end unit, angled</p> <p> Not for use in conjunction with LED light screens!</p>	43	2,2	51,5	075	
 <p>1 shelf for extended corner unit</p> <p> Not for use in conjunction with LED light screens!</p>	88	2,2	88	073	
 <p>1 shelf for extended walk-in corner unit</p>	72,2	2,2	51,5	074	
 <p>Hanging rail</p> <ul style="list-style-type: none"> - for compartment width 34,5 cm - for compartment width 47.5 cm - for compartment width 72.2 cm - for compartment width 96.4 cm 	34,5	3	2	048	
	47,5	3	2	049	
	72,2	3	2	052	
	96,4	3	2	050	
 <p>1 hanging rail for extended corner unit</p> <p> Only for assembly under one shelf!</p>	95,8	3	2	082	

Monaco 5000.

Independent / non HDI



BLANK PRICE LIST

valid until 28.02.2025

V.i.P.
by Wiemann

Unit accessories

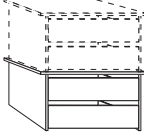
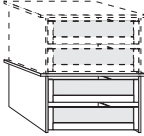
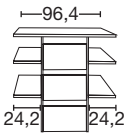
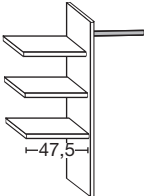
Interior finish: silver grey striped

Description	Dimensions cm			Art. no.	GBP
	W	H	D		
 <p>Drawer insert with 2 drawers and wooden front, stackable and height adjustable</p> <p>- for compartment width 72.2 cm - for compartment width 96.4 cm</p>	72,2 96,4	41 41	51,5 51,5	071 072	
 <p>Drawer insert with 2 drawers with self-closing mechanism and glass front, stackable and height adjustable</p> <p>- for compartment width 72.2 cm - for compartment width 96.4 cm</p>	72,2 96,4	41 41	51,5 51,5	069 070	
 <p>Drawer insert with 3 drawers and wooden front</p> <p>- for compartment width 72.2 cm - for compartment width 96.4 cm</p> <p>Art. no. 064</p>	72,2 96,4	89 89	51,5 51,5	065 064	
 <p>Laundry shelf insert, consisting of: 3 adjustable shelves, 1 clothes rail, 1 centre partition</p> <p>- for compartment width 72.2 cm - for compartment width 96.4 cm</p>	72,2 96,4	137 137	51,5 51,5	025 066	
 <p>For use on both sides (left or right)!</p> <p>Only to be placed on base plinth!</p>					



Monaco 5000.

Independent / non HDI
BLANK PRICE LIST
 valid until **28.02.2025**

V.i.P.
 by Wiemann

Unit accessories

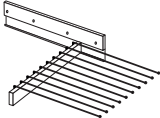
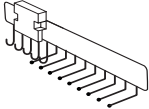
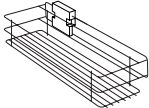
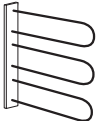
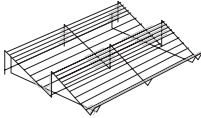
Interior finish: silver grey striped

Description	Dimensions cm			Art. no.	GBP
	W	H	D		
 <p>Trousers holder</p>	45	10	50	056	
 <p>Tie and belt pull-out</p>	7	19	45	059	
 <p>Utensil pull-out</p>	16	9	45	076	
 <p>Tie and belt rack</p>	30	27	9	042	
 <p>Shoe rack for unit compartment W 96.4 cm</p>	96	15	50	080	
 <p>Clothes lift for compartment width 72.3 - 96.4 cm</p>	100	85	14	081	

Monaco 5000.

Independent / non HDI

BLANK PRICE LIST

valid until 28.02.2025

V.i.P.
by Wiemann

Unit accessories

Interior finish: silver grey striped

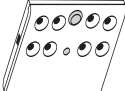
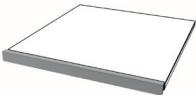
Description	Dimensions cm			Art. no.	GBP
	W	H	D		
 <p>LED Wardrobe interior lights with motion detector, incl. rechargeable battery via USB</p>	1 item	10	2	10	006
	2 items	10	2	10	007
	3 items	10	2	10	008
	4 items	10	2	10	009
 <p>LED Light screen for shelves as continuous light with foot switch</p> <p>- for compartment width 47.5 cm 1 item</p> <p>- for compartment width 72.2 cm 1 item</p> <p>- for compartment width 96.4 cm 1 item</p> <p>- for compartment width 47.5 cm 2 items</p> <p>- for compartment width 72.2 cm 2 items</p> <p>- for compartment width 96.4 cm 2 items</p> <p>- for compartment width 47.5 cm 3 items</p> <p>- for compartment width 72.2 cm 3 items</p> <p>- for compartment width 96.4 cm 3 items</p> <p>This product contains a light device of energy efficiency class C</p>					