

Monaco 3000.

Sliding door wardrobes.

V.i.P.
by Wiemann



Independent / non HDI
BLANK PRICE LIST
 valid 01.03.2023-31.08.2023



Emission Tested
 Tested for Harmful
 Substances
 Regular Product
 Surveillance
 www.tuv.com
 ID 1111263053



Wardrobe system Monaco.

V.i.P.
by Wiemann

Monaco 1000
Hinged-door wardrobes

Monaco 2000
Wardrobes with bi-fold doors

Monaco 1000+2000
Functional units

Monaco 3000
Sliding door wardrobes

Monaco 4000
Beds + Occasional furniture



MONACO 3000 – Free Standing Wardrobes

Wardrobe suggestions

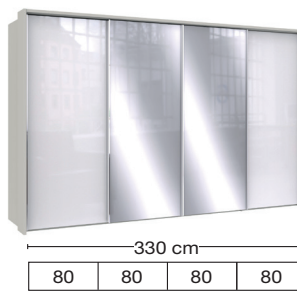
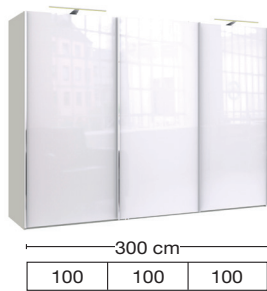

Centre doors with synchronous-opening

For these free standing wardrobes passepartout frames and cornices are available optionally either with our without lights (see accessories).

Wardrobe line ups (individually combined) based on MONACO 1000 + 2000 + 3000

1. Example:

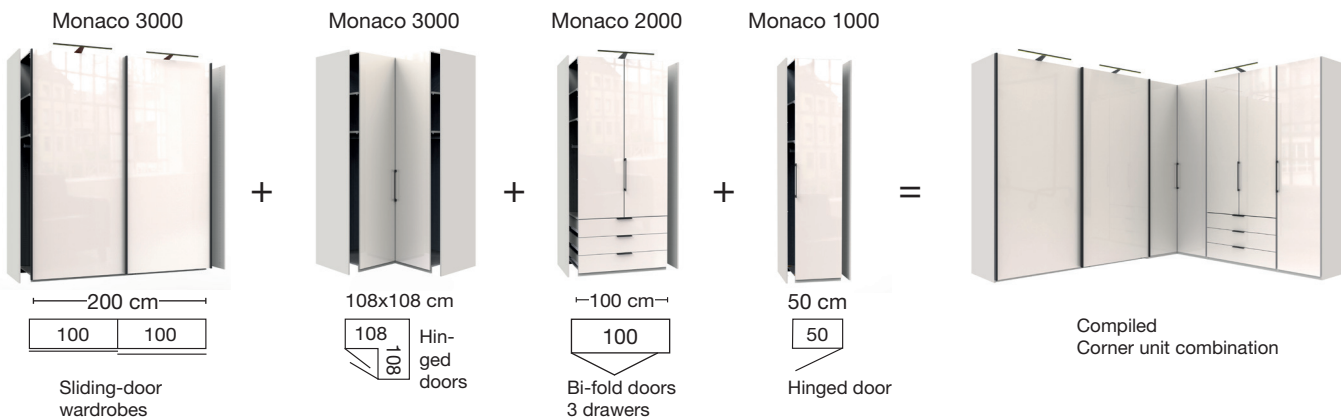

2. Example:

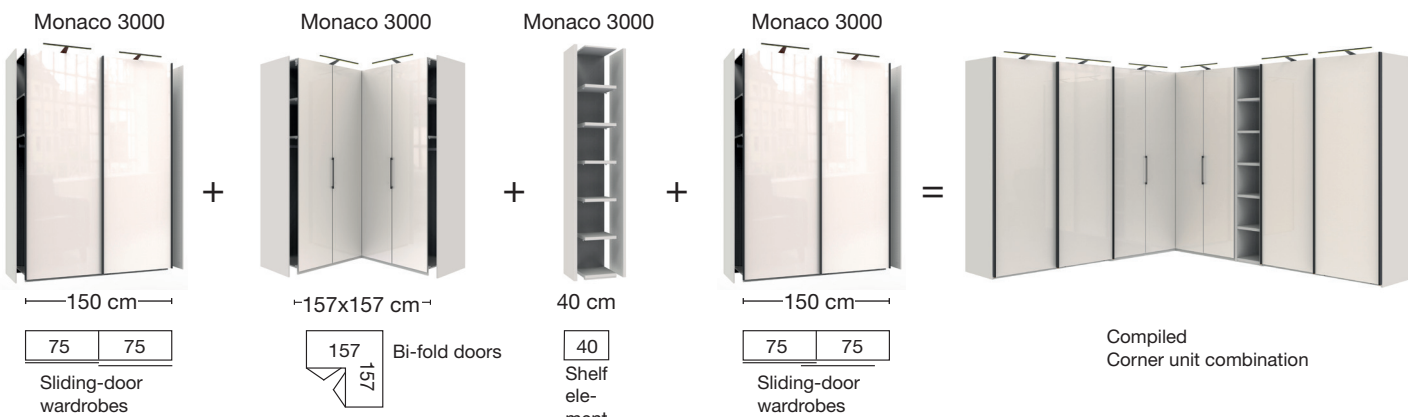

The single wardrobes include two end panels each and can get placed beside each other. Optional On-Top lights available.

Monaco 3000.

Independent / non HDI

BLANK PRICE LIST

valid

01.03.2023-31.08.2023

V.i.P.
by Wiemann

Carcase and front colours

Please specify the exact colour combination of front and carcase colour for each order!

Designs:

		
Handles in chrome	Handle ledges in silver	Handles in slate finish
		
		
Model no. 334 Bianco oak finish	Model no. 345 Bianco oak finish	Model no. 349 Bianco oak finish
		
Model no. 342 White	Model no. 346 White	Model no. 357 White
		
Model no. 343 Pebble grey finish	Model no. 347 Pebble grey finish	Model no. 358 Pebble grey finish
		
Model no. 344 Champagne finish	Model no. 348 Champagne finish	Model no. 359 Champagne finish
		
Modell-Nr. 395 Graphite	Model no. 480 Graphite	Model no. 490 Graphite

Monaco 3000.

Sliding door wardrobes.

V.i.P.
by Wiemann

Front colours:

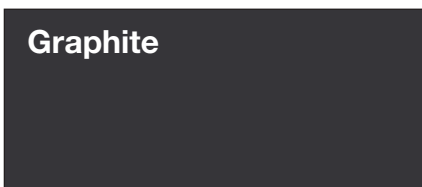
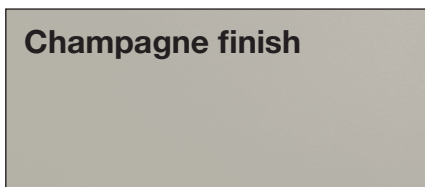
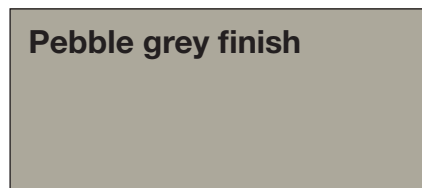
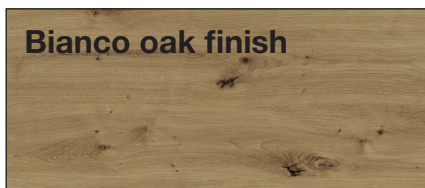

Glass fronts

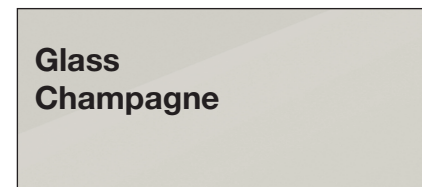
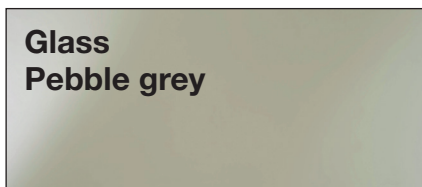
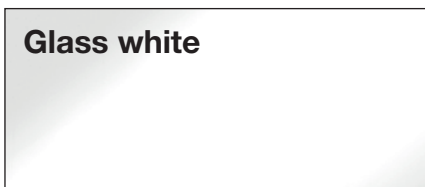

Mirror

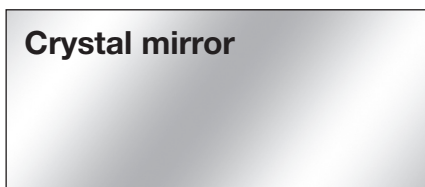

Interior colour

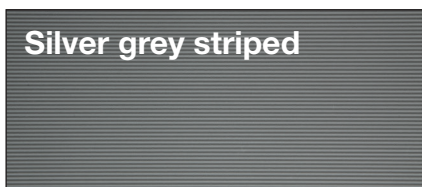

Monaco 3000.**Sliding door wardrobes.****V.i.P.**
by Wiemann**Carcase width****Sliding door wardrobes**

Width	Side	Plinth	Side	Plinth	Side	Plinth	Side	Plinth	Side	Width effective
150	1,5	72,2	1,5	72,2	1,5					148,9 cm
200	1,5	96,4	1,5	96,4	1,5					197,3 cm
225	1,5	72,2	1,5	72,2	1,5	72,2	1,5			222,6 cm
250	1,5	80,1	1,5	80,1	1,5	80,1	1,5			246,3 cm
280	1,5	96,4	1,5	80,1	1,5	96,4	1,5			278,9 cm
300	1,5	96,4	1,5	96,4	1,5	96,4	1,5			295,2 cm
300	1,5	72,2	1,5	72,2	1,5	72,2	1,5	72,2	1,5	296,3 cm
330	1,5	80,1	1,5	80,1	1,5	80,1	1,5	80,1	1,5	327,9 cm
400	1,5	96,4	1,5	96,4	1,5	96,4	1,5	96,4	1,5	393,1 cm

furnplan

Emission Tested
Tested for Harmful
Substances
Regular Product
Surveillance

www.tuv.com
ID 1111253053

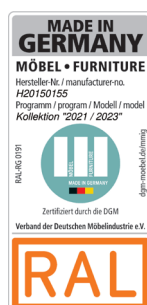

Monaco 3000.

Independent / non HDI

BLANK PRICE LIST

valid

01.03.2023-31.08.2023

V.i.P.
by Wiemann







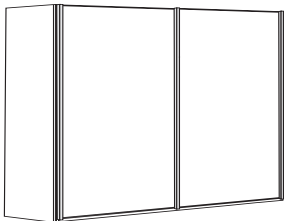
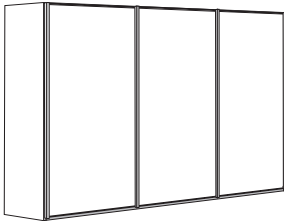
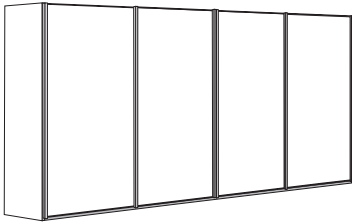







Sliding door wardrobes

Interior:

2 adjustable shelves, 1 clothes rail

Description	Dimensions		Height 217 cm		Height 236 cm	
	W	D	Art. no.	GBP	Art. no.	GBP
Front in carcass colour						
	2 doors	150	67	200		209
	2 doors	200	67	201		210
	3 doors	225	67	202		211
	3 doors	250	67	203		212
	3 doors	280	67	204		213
	3 doors	300	67	205		214
	- with synchronous opening					
	4 doors	300	67	206		215
	4 doors	330	67	207		216
	4 doors	400	67	208		217

Plinth partition

														
150 cm	200 cm	225 cm	250 cm	280 cm	300 cm	300 cm	330 cm	400 cm						
72,2 cm	72,2 cm	96,4 cm	96,4 cm	72,2 cm	72,2 cm	72,2 cm	72,2 cm	80,1 cm	80,1 cm	80,1 cm	80,1 cm	96,4 cm	80,1 cm	96,4 cm
96,4 cm	96,4 cm	96,4 cm	72,2 cm	72,2 cm	72,2 cm	72,2 cm	80,1 cm	80,1 cm	80,1 cm	80,1 cm	96,4 cm	96,4 cm	96,4 cm	96,4 cm

Monaco 3000.

Independent / non HDI

BLANK PRICE LIST

valid



01.03.2023-31.08.2023

V.i.P.
by Wiemann





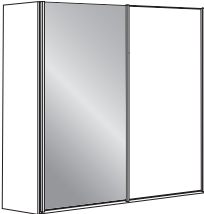
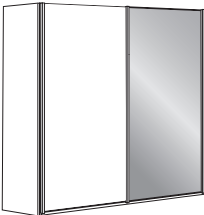
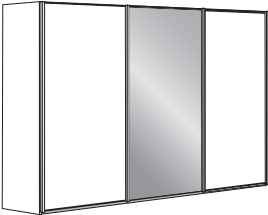
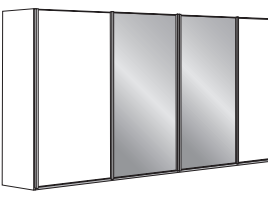
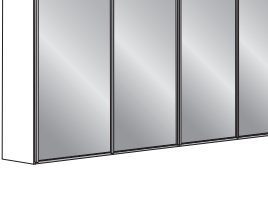
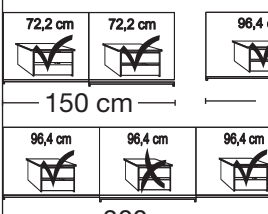

























Sliding door wardrobes

Interior:

2 adjustable shelves, 1 clothes rail

Description	Dimensions		Height 217 cm		Height 236 cm	
	W	D	Art. no.	GBP	Art. no.	GBP
Front in carcase colour and crystal mirrored doors						
	2 doors 1 mirrored door left	150	67	218		238
	2 doors 1 mirrored door right	150	67	219		239
	2 doors 2 mirrored doors	150	67	220		240
	2 doors 1 mirrored door left	200	67	221		241
	2 doors 1 mirrored door right	200	67	222		242
	2 doors 2 mirrored doors	200	67	223		243
	3 doors 1 centre mirrored door	225	67	224		244
	3 doors 3 mirrored doors	225	67	225		245
	3 doors 1 centre mirrored door	250	67	226		246
	3 doors 3 mirrored doors	250	67	227		247
	3 doors 1 centre mirrored door	280	67	228		248
	3 doors 3 mirrored doors	280	67	229		249
	3 doors 1 centre mirrored door	300	67	230		250
	3 doors 3 mirrored doors	300	67	231		251
	- with synchronous opening					
	4 doors 2 centre mirrored doors	300	67	232		252
	4 doors 4 mirrored doors	300	67	233		253
	4 doors 2 centre mirrored doors	330	67	234		254
	4 doors 4 mirrored doors	330	67	235		255
	4 doors 2 centre mirrored doors	400	67	236		256
	4 doors 4 mirrored doors	400	67	237		257

Plinth partition

															
72,2 cm	72,2 cm	96,4 cm	96,4 cm	72,2 cm	72,2 cm	72,2 cm	72,2 cm	80,1 cm	80,1 cm	80,1 cm	96,4 cm	80,1 cm	96,4 cm		
150 cm		200 cm		225 cm			250 cm			280 cm					
															
96,4 cm	96,4 cm	96,4 cm	72,2 cm	72,2 cm	72,2 cm	72,2 cm	80,1 cm	80,1 cm	80,1 cm	80,1 cm	96,4 cm	96,4 cm	96,4 cm	96,4 cm	
300 cm			300 cm				330 cm				400 cm				

Monaco 3000.

Independent / non HDI

BLANK PRICE LIST

valid

01.03.2023-31.08.2023

V.i.P.

 by Wiemann







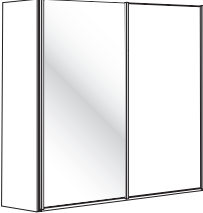
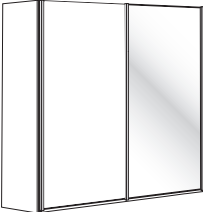
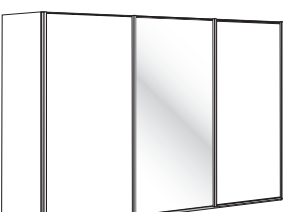
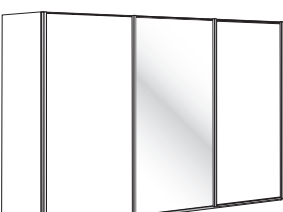
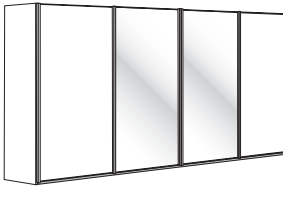
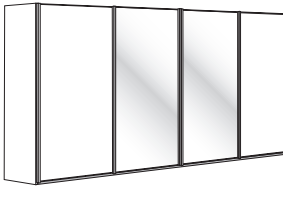
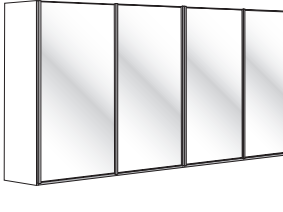





















Sliding door wardrobes

Interior:

2 adjustable shelves, 1 clothes rail

Description	Dimensions		Height 217 cm		Height 236 cm	
	W	D	Art. no.	GBP	Art. no.	GBP
Glass doors in white in combination with doors in carcass colour						
	2 doors	1 glass door left	150	67	258	278
	2 doors	1 glass door right	150	67	259	279
	2 doors	2 glass doors	150	67	260	280
	2 doors	1 glass door left	200	67	261	281
	2 doors	1 glass door right	200	67	262	282
	2 doors	2 glass doors	200	67	263	283
	3 doors	1 centre glass door	225	67	264	284
	3 doors	3 glass doors	225	67	265	285
	3 doors	1 centre glass door	250	67	266	286
	3 doors	3 glass doors	250	67	267	287
	3 doors	1 centre glass door	280	67	268	288
	3 doors	3 glass doors	280	67	269	289
	3 doors	1 centre glass door	300	67	270	290
	3 doors	3 glass doors	300	67	271	291
	- with synchronous opening					
	4 doors	2 centre glass doors	300	67	272	292
	4 doors	4 glass doors	300	67	273	293
	4 doors	2 centre glass doors	330	67	274	294
	4 doors	4 glass doors	330	67	275	295
	4 doors	2 centre glass doors	400	67	276	296
	4 doors	4 glass doors	400	67	277	297

Plinth partition

														
150 cm		200 cm		225 cm			250 cm			280 cm				
														
300 cm			300 cm				330 cm				400 cm			

Monaco 3000.

Independent / non HDI

BLANK PRICE LIST

valid

01.03.2023-31.08.2023

V.i.P.

 by Wiemann

Sliding door wardrobes

Interior:

2 adjustable shelves, 1 clothes rail

Description	Dimensions		Height 217 cm		Height 236 cm	
	W	D	Art. no.	GBP	Art. no.	GBP
Glass doors in white and crystal mirrored doors						
	2 doors 1 mirrored door left	150	67	298		318
	2 doors 1 mirrored door right	150	67	299		319
	2 doors 2 mirrored doors	150	67	300		320
	2 doors 1 mirrored door left	200	67	301		321
	2 doors 1 mirrored door right	200	67	302		322
	2 doors 2 mirrored doors	200	67	303		323
	3 doors 1 centre mirrored door	225	67	304		324
	3 doors 3 mirrored doors	225	67	305		325
	3 doors 1 centre mirrored door	250	67	306		326
	3 doors 3 mirrored doors	250	67	307		327
	3 doors 1 centre mirrored door	280	67	308		328
	3 doors 3 mirrored doors	280	67	309		329
	3 doors 1 centre mirrored door	300	67	310		330
	3 doors 3 mirrored doors	300	67	311		331
	- with synchronous opening					
	4 doors 2 centre mirrored doors	300	67	312		332
	4 doors 4 mirrored doors	300	67	313		333
	4 doors 2 centre mirrored doors	330	67	314		334
	4 doors 4 mirrored doors	330	67	315		335
	4 doors 2 centre mirrored doors	400	67	316		336
	4 doors 4 mirrored doors	400	67	317		337

Plinth partition

150 cm	200 cm	225 cm	250 cm	280 cm
300 cm	300 cm	330 cm	400 cm	

Monaco 3000.

Independent / non HDI

BLANK PRICE LIST

valid

01.03.2023-31.08.2023

V.i.P.

 by Wiemann







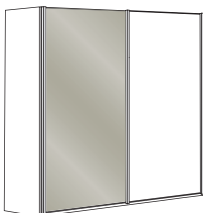
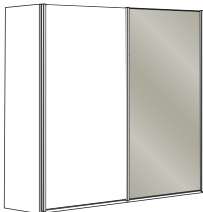
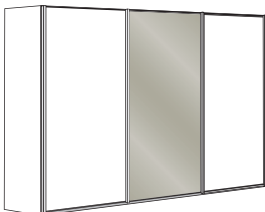
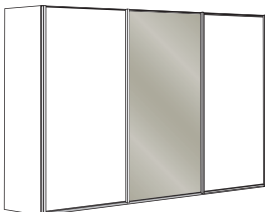
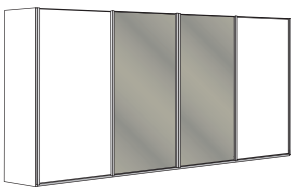
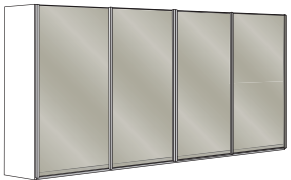
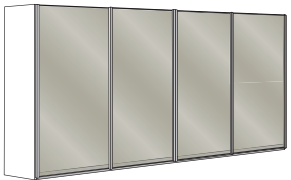























Sliding door wardrobes

Interior:

2 adjustable shelves, 1 clothes rail

Description	Dimensions		Height 217 cm		Height 236 cm	
	W	D	Art. no.	GBP	Art. no.	GBP
Glass doors in pebble grey in combination with doors in carcase colour						
	2 doors 1 glass door left	150	67	338		358
	2 doors 1 glass door right	150	67	339		359
	2 doors 2 glass doors	150	67	340		360
	2 doors 1 glass door left	200	67	341		361
	2 doors 1 glass door right	200	67	342		362
	2 doors 2 glass doors	200	67	343		563
	3 doors 1 centre glass door	225	67	344		564
	3 doors 3 glass doors	225	67	345		565
	3 doors 1 centre glass door	250	67	346		366
	3 doors 3 glass doors	250	67	347		367
	3 doors 1 centre glass door	280	67	348		368
	3 doors 3 glass doors	280	67	349		569
	3 doors 1 centre glass door	300	67	350		570
	3 doors 3 glass doors	300	67	351		371
	- with synchronous opening					
	4 doors 2 centre glass doors	300	67	352		372
	4 doors 4 glass doors	300	67	353		373
	4 doors 2 centre glass doors	330	67	354		374
	4 doors 4 glass doors	330	67	355		375
	4 doors 2 centre glass doors	400	67	356		376
	4 doors 4 glass doors	400	67	357		377

Plinth partition

														
72,2 cm	72,2 cm	96,4 cm	96,4 cm	72,2 cm	72,2 cm	72,2 cm	72,2 cm	80,1 cm	80,1 cm	80,1 cm	96,4 cm	80,1 cm	96,4 cm	
150 cm		200 cm		225 cm			250 cm			280 cm				
														
96,4 cm	96,4 cm	96,4 cm	72,2 cm	72,2 cm	72,2 cm	72,2 cm	80,1 cm	80,1 cm	80,1 cm	80,1 cm	96,4 cm	96,4 cm	96,4 cm	96,4 cm
300 cm			300 cm				330 cm				400 cm			

Monaco 3000.

Independent / non HDI

BLANK PRICE LIST

valid

01.03.2023-31.08.2023



V.i.P.

 by Wiemann





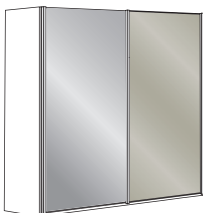
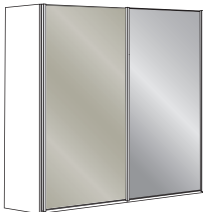

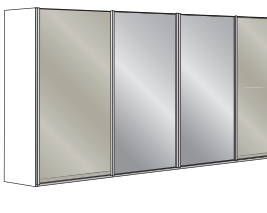
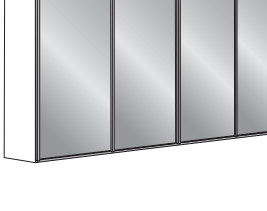
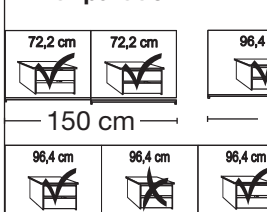
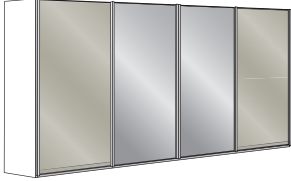
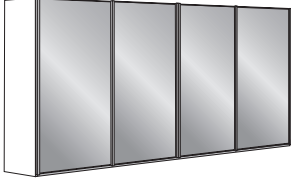
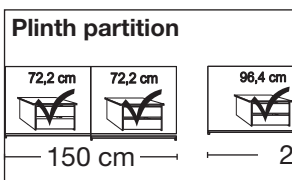





















Sliding door wardrobes

Interior:

2 adjustable shelves, 1 clothes rail

Description	Dimensions		Height 217 cm		Height 236 cm	
	W	D	Art. no.	GBP	Art. no.	GBP
Glass doors in pebble grey and crystal mirrored doors						
 2 doors 1 mirrored door left	150	67	378		398	
2 doors 1 mirrored door right	150	67	379		399	
2 doors 2 mirrored doors	150	67	380		400	
 2 doors 1 mirrored door left	200	67	381		401	
2 doors 1 mirrored door right	200	67	382		402	
2 doors 2 mirrored doors	200	67	383		403	
 3 doors 1 centre mirrored door	225	67	384		404	
3 doors 3 mirrored doors	225	67	385		405	
 3 doors 1 centre mirrored door	250	67	386		406	
3 doors 3 mirrored doors	250	67	387		407	
 3 doors 1 centre mirrored door	280	67	388		408	
3 doors 3 mirrored doors	280	67	389		409	
 3 doors 1 centre mirrored door	300	67	390		410	
3 doors 3 mirrored doors	300	67	391		411	
- with synchronous opening						
 4 doors 2 centre mirrored doors	300	67	392		412	
4 doors 4 mirrored doors	300	67	393		413	
 4 doors 2 centre mirrored doors	330	67	394		414	
4 doors 4 mirrored doors	330	67	395		415	
 4 doors 2 centre mirrored doors	400	67	396		416	
4 doors 4 mirrored doors	400	67	397		417	

Plinth partition

 72,2 cm	 72,2 cm	 96,4 cm	 96,4 cm	 72,2 cm	 72,2 cm	 72,2 cm	 80,1 cm	 80,1 cm	 80,1 cm	 96,4 cm	 80,1 cm	 96,4 cm		
150 cm		200 cm		225 cm			250 cm			280 cm				
 96,4 cm	 96,4 cm	 96,4 cm	 72,2 cm	 72,2 cm	 72,2 cm	 72,2 cm	 80,1 cm	 80,1 cm	 80,1 cm	 80,1 cm	 96,4 cm	 96,4 cm	 96,4 cm	 96,4 cm
300 cm			300 cm				330 cm				400 cm			

Monaco 3000.

Independent / non HDI

BLANK PRICE LIST

valid

01.03.2023-31.08.2023

V.i.P.

 by Wiemann







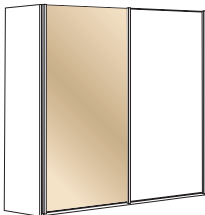
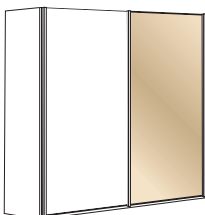
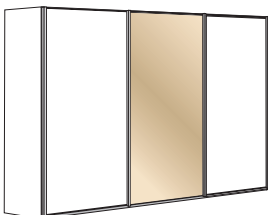
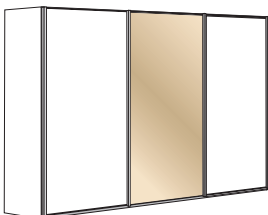
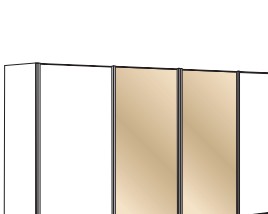
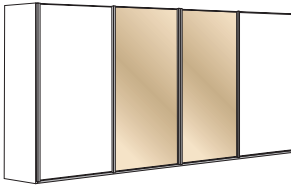
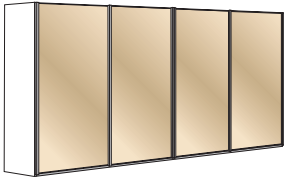























Sliding door wardrobes

Interior:

2 adjustable shelves, 1 clothes rail

Description	Dimensions		Height 217 cm		Height 236 cm	
	W	D	Art. no.	GBP	Art. no.	GBP
Glass doors in champagne in combination with doors in carcase colour						
	2 doors 1 glass door left	150	67	418		438
	2 doors 1 glass door right	150	67	419		439
	2 doors 2 glass doors	150	67	420		440
	2 doors 1 glass door left	200	67	421		441
	2 doors 1 glass door right	200	67	422		442
	2 doors 2 glass doors	200	67	423		443
	3 doors 1 centre glass door	225	67	424		444
	3 doors 3 glass doors	225	67	425		445
	3 doors 1 centre glass door	250	67	426		446
	3 doors 3 glass doors	250	67	427		447
	3 doors 1 centre glass door	280	67	428		448
	3 doors 3 glass doors	280	67	429		449
	3 doors 1 centre glass door	300	67	430		450
	3 doors 3 glass doors	300	67	431		451
	- with synchronous opening					
	4 doors 2 centre glass doors	300	67	432		452
	4 doors 4 glass doors	300	67	433		453
	4 doors 2 centre glass doors	330	67	434		454
	4 doors 4 glass doors	330	67	435		455
	4 doors 2 centre glass doors	400	67	436		456
	4 doors 4 glass doors	400	67	437		457

Plinth partition

														
72,2 cm	72,2 cm	96,4 cm	96,4 cm	72,2 cm	72,2 cm	72,2 cm	72,2 cm	80,1 cm	80,1 cm	80,1 cm	96,4 cm	80,1 cm	96,4 cm	
150 cm		200 cm		225 cm			250 cm			280 cm				
														
96,4 cm	96,4 cm	96,4 cm	72,2 cm	72,2 cm	72,2 cm	72,2 cm	80,1 cm	80,1 cm	80,1 cm	80,1 cm	96,4 cm	96,4 cm	96,4 cm	96,4 cm
300 cm			300 cm				330 cm				400 cm			

Monaco 3000.

Independent / non HDI

BLANK PRICE LIST

valid

01.03.2023-31.08.2023

V.i.P.

 by Wiemann







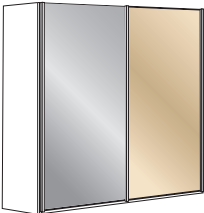
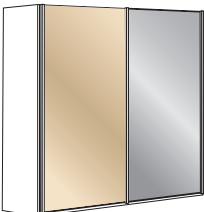
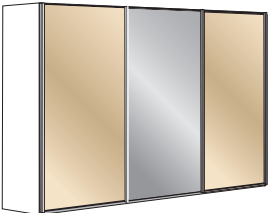
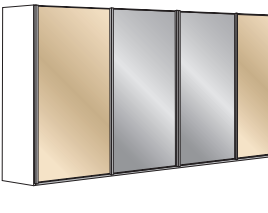
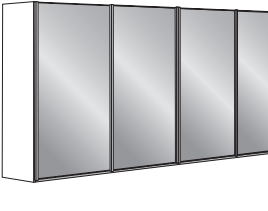
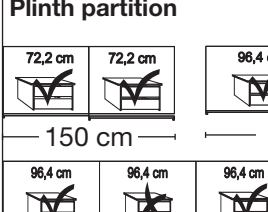
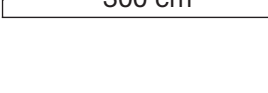























Sliding door wardrobes

Interior:

2 adjustable shelves, 1 clothes rail

Description	Dimensions		Height 217 cm		Height 236 cm	
	W	D	Art. no.	GBP	Art. no.	GBP
Glass doors in champagne and crystal mirrored doors						
	2 doors 1 mirrored door left	150	67	458		478
	2 doors 1 mirrored door right	150	67	459		479
	2 doors 2 mirrored doors	150	67	460		480
	2 doors 1 mirrored door left	200	67	461		481
	2 doors 1 mirrored door right	200	67	462		482
	2 doors 2 mirrored doors	200	67	463		483
	3 doors 1 centre mirrored door	225	67	464		484
	3 doors 3 mirrored doors	225	67	465		485
	3 doors 1 centre mirrored door	250	67	466		486
	3 doors 3 mirrored doors	250	67	467		487
	3 doors 1 centre mirrored door	280	67	468		488
	3 doors 3 mirrored doors	280	67	469		489
	3 doors 1 centre mirrored door	300	67	470		490
	3 doors 3 mirrored doors	300	67	471		491
	- with synchronous opening					
	4 doors 2 centre mirrored doors	300	67	472		492
	4 doors 4 mirrored doors	300	67	473		493
	4 doors 2 centre mirrored doors	330	67	474		494
	4 doors 4 mirrored doors	330	67	475		495
	4 doors 2 centre mirrored doors	400	67	476		496
	4 doors 4 mirrored doors	400	67	477		497

Plinth partition

														
72,2 cm	72,2 cm	96,4 cm	96,4 cm	72,2 cm	72,2 cm	72,2 cm	72,2 cm	80,1 cm	80,1 cm	80,1 cm	96,4 cm	80,1 cm	96,4 cm	
150 cm		200 cm		225 cm			250 cm			280 cm				
														
96,4 cm	96,4 cm	96,4 cm	72,2 cm	72,2 cm	72,2 cm	72,2 cm	80,1 cm	80,1 cm	80,1 cm	80,1 cm	96,4 cm	96,4 cm	96,4 cm	96,4 cm
300 cm			300 cm				330 cm				400 cm			

Monaco 3000.

Independent / non HDI

BLANK PRICE LIST

valid



01.03.2023-31.08.2023

V.i.P.
by Wiemann

Corner units without cornice

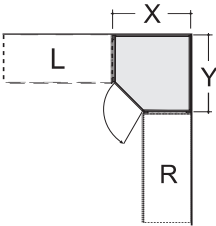
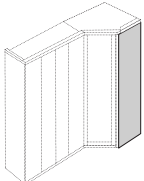

In combination with sliding door wardrobes, no cornices or passepartout frames are possible!

Description	Dimensions		Height 216 cm		Height 236 cm		
	W	D	Art. no.	GBP	Art. no.	GBP	
   <p>Layout (plan view) see page 19/20</p> <p>Interior: 2 shelves, 1 clothes rail per compartment All hinged-doors incl. cushioned hinges</p>	<p>Extended corner unit</p> <p>Door hinged left:</p> <p>1 door - Front in carcass colour 93 93 774 779</p> <p>1 door - Front glass white 93 93 775 780</p> <p>1 door - Front glass pebble grey 93 93 776 781</p> <p>1 door - Front glass champagne 93 93 777 782</p> <p>1 door - Front crystal mirror 93 93 778 783</p> <hr/> <p>Door hinged right:</p> <p>1 door - Front in carcass colour 93 93 784 789</p> <p>1 door - Front glass white 93 93 785 790</p> <p>1 door - Front glass pebble grey 93 93 786 791</p> <p>1 door - Front glass champagne 93 93 787 792</p> <p>1 door - Front crystal mirror 93 93 788 793</p>						
	 <p>End panel for extended corner unit, can be used on right and left</p> <p>Required with a final extended corner unit. If a corner unit stands separately, 2 outer sides are required.</p> <p>Not useable in conjunction with cornices!</p>	56	1,5	090		091	

Monaco 3000.

Independent / non HDI

BLANK PRICE LIST

valid

01.03.2023-31.08.2023

V.i.P.
by Wiemann

Corner units without cornice

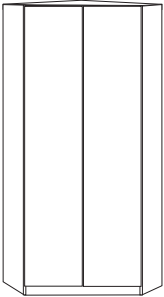
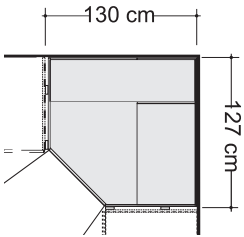
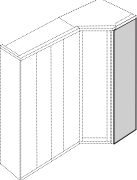

In combination with sliding door wardrobes, no cornices or passepartout frames are possible!

Description	Dimensions		Height 216 cm		Height 236 cm	
	W	D	Art. no.	GBP	Art. no.	GBP
 <p>Walk-in corner unit with hinged doors</p> <p>2 doors - Front in carcass colour</p> <p>2 doors - Front glass white</p> <p>2 doors - Front glass pebble grey</p> <p>2 doors - Front glass champagne</p> <p>2 doors - Front crystal mirror</p> <p>Layout (plan view) see page 19/20</p>  <p>Interior: W 72.2cm: 2 shelves, 1 hanging rail, W 125 cm: 5 shelves, Lights with motion detector</p> <p>All hinged-doors incl. cushioned hinges</p> <p>This product contains a light device of energy efficiency class G</p>						
			799		809	
			800		810	
			801		811	
			802		812	
			803		813	
 <p>End panel for walk-in corner unit, can be used on right and left</p> <p>Required if a corner unit is used on end. If a corner unit is mounted separately, 2 outer panels are required.</p> <p>Not useable in conjunction with cornices!</p>	56	1,5	090		091	

Monaco 3000.

Independent / non HDI

BLANK PRICE LIST

valid





01.03.2023-31.08.2023

V.i.P.
by Wiemann

Corner units without cornice

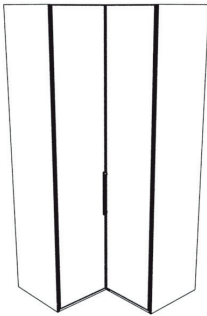

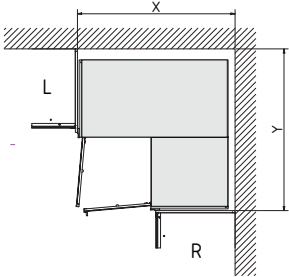
In combination with sliding door wardrobes, no cornices or passepartout frames are possible!

Description	Dimensions		Height 216 cm		Height 236 cm	
	W	D	Art. no.	GBP	Art. no.	GBP
 <p>Corner unit, 90 degree with hinged doors</p> <ul style="list-style-type: none"> - Front in carcase colour - Front glass white - Front glass pebble grey - Front glass champagne - Front crystal mirror 	108	108	968		992	
	108	108	969		993	
	108	108	989		994	
	108	108	990		995	
	108	108	991		996	
						
 <p>Layout (plan view) see page 19/20</p>						
<p>Interior: 2 shelves 105cm x 105cm, 2 hanging rails 71.5 cm</p>						
 <p>Doors without cushioners!</p>						

Monaco 3000.

Independent / non HDI

BLANK PRICE LIST

valid



01.03.2023-31.08.2023

V.i.P.
by Wiemann

Corner units without cornice

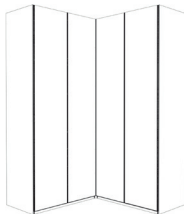

In combination with sliding door wardrobes, no cornices or passepout frames are possible!

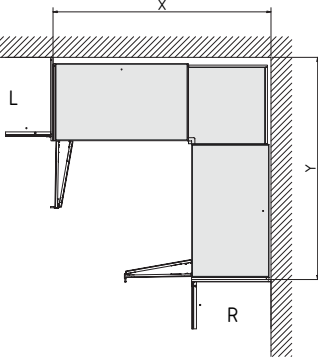
Description	Dimensions		Height 216 cm		Height 236 cm	
	W	D	Art. no.	GBP	Art. no.	GBP
 <p>Corner unit, 90 degree with bi-fold doors</p> <ul style="list-style-type: none"> - Front in carcase colour - Front glass white - Front glass pebble grey - Front glass champagne - Front crystal mirror 	157	157	814		819	
	157	157	815		820	
	157	157	816		821	
	157	157	817		822	
	157	157	818		823	
						
						
<p>Interior: W 55.8 cm: 2 shelves W 96.4 cm: 4 shelves 2 hanging rails 152 cm</p>						

Monaco 3000.

Independent / non HDI

BLANK PRICE LIST

valid

01.03.2023-31.08.2023

V.i.P.
by Wiemann

Size over view for corner robe

Due to different depth dimensions
there are different space requirements:

Wardrobe Side L	Wardrobe Side R	Required space for extended corner unit
Hinged-/ Bi-fold-wardrobe, Shelf element	Sliding-door wardrobe, 2-4 doors	X = 98,0 cm Y = 94,2 cm
Sliding-door wardrobe, 2 doors	Hinged-/ Bi-fold-wardrobe, Shelf element	X = 94,2 cm Y = 101,0 cm
Sliding-door wardrobe, 3-4 doors	Hinged-/ Bi-fold-wardrobe, Shelf element	X = 94,2 cm Y = 98,0 cm
Sliding-door wardrobe, 2 doors	Sliding-door wardrobe, 2-4 doors	X = 99,2 cm Y = 102,2 cm
Sliding-door wardrobe, 3-4 doors	Sliding-door wardrobe, 2-4 doors	X = 99,2 cm Y = 99,2 cm

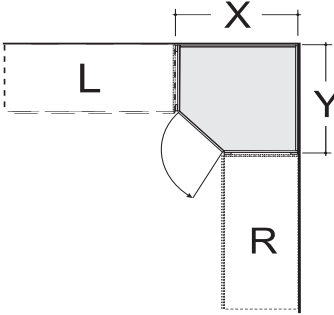



Extended corner unit

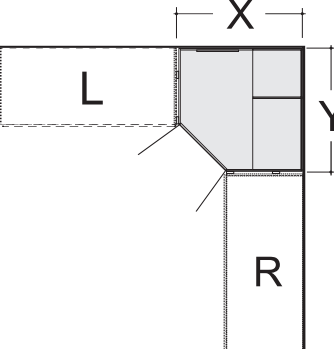

Wardrobe Side L	Wardrobe Side R	Required space for walk-in corner unit
Hinged-/ Bi-fold-wardrobe, Shelf element	Sliding-door wardrobe, 2-4 doors	X = 134,4 cm Y = 126,9 cm
Sliding-door wardrobe, 2 doors	Hinged-/ Bi-fold-wardrobe, Shelf element	X = 130,6 cm Y = 134,2 cm
Sliding-door wardrobe, 3-4 doors	Hinged-/ Bi-fold-wardrobe, Shelf element	X = 130,6 cm Y = 131,2 cm
Sliding-door wardrobe, 2 doors	Sliding-door wardrobe, 2-4 doors	X = 135,6 cm Y = 135,4 cm
Sliding-door wardrobe, 3-4 doors	Sliding-door wardrobe, 2-4 doors	X = 135,6 cm Y = 132,4 cm



**Walk-in corner unit with
hinged doors**



Monaco 3000.

Independent / non HDI

BLANK PRICE LIST

valid

01.03.2023-31.08.2023

V.i.P.
by Wiemann

Size over view for corner robe

Due to different depth dimensions
there are different space requirements:

Wardrobe Side L	Wardrobe Side R	Required space for 90 degree corner unit with hinged door	
Hinged-/ Bi-fold-wardrobe, Shelf element	Sliding-door wardrobe, 2-4 doors	X = 114,2 cm Y = 107,9 cm	
Sliding-door wardrobe, 2 doors	Hinged-/ Bi-fold-wardrobe, Shelf element	X = 107,9 cm Y = 117,2 cm	
Sliding-door wardrobe, 3-4 doors	Hinged-/ Bi-fold-wardrobe, Shelf element	X = 107,9 cm Y = 114,2 cm	
Sliding-door wardrobe, 2 doors	Sliding-door wardrobe, 2-4 doors	X = 114,2 cm Y = 117,2 cm	
Sliding-door wardrobe, 3-4 doors	Sliding-door wardrobe, 2-4 doors	X = 114,2 cm Y = 114,2 cm	
			Corner unit, 90 degree with hinged-doors

Wardrobe Side L	Wardrobe Side R	Required space for 90 degree corner unit with bi-fold door	
Hinged-/ Bi-fold-wardrobe, Shelf element	Sliding-door wardrobe, 2-4 doors	X = 158,0 cm Y = 156,5 cm	
Sliding-door wardrobe, 2 doors	Hinged-/ Bi-fold-wardrobe, Shelf element	X = 156,5 cm Y = 161,0 cm	
Sliding-door wardrobe, 3-4 doors	Hinged-/ Bi-fold-wardrobe, Shelf element	X = 156,5 cm Y = 158,0 cm	
Sliding-door wardrobe, 2 doors	Sliding-door wardrobe, 2-4 doors	X = 158,0 cm Y = 161,0 cm	
Sliding-door wardrobe, 3-4 doors	Sliding-door wardrobe, 2-4 doors	X = 158,0 cm Y = 158,0 cm	
			Corner unit, 90 degree with bi-fold-doors

Monaco 3000.

Independent / non HDI

BLANK PRICE LIST

valid

01.03.2023-31.08.2023



V.i.P.
by Wiemann

Shelf element without cornice

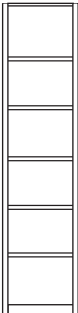
**Not for use in conjunction with passe-partout-frames and cornices!**

Description	Dimensions		Height 216 cm		Height 236 cm	
	W	D	Art. no.	GBP	Art. no.	GBP
 <p>Open shelf element in carcass colour, with 5 shelves</p>	40	36	840		841	

Unit accessories

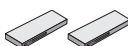
Description	Dimensions cm			Art. no.	GBP
	W	H	D		
 <p>Bumper</p> <p>- for 2-doors wardrobes 1 item</p> <p>Optimal functioning only in combination with self-closing mechanism for outer doors</p> <p>- for 3-4 door wardrobes 2 items</p> <p>Best performance in conjunction with soft closing mechanism!</p>	28	4	2	369	
 <p>Soft-closing mechanism for middle doors</p> <p>- for 3-door units * piece</p> <p>- for 4-door units piece</p> <p>* Please pay attention to clearance between wardrobe and ceiling! To be fitted from top of the wardrobe!</p>	24	2	11	363	
 <p>2-piece set self-closing mechanism with buffering for outer doors, Set for 2-,3- and 4-doors</p> <p>pair</p>	24	2	11	365	

Monaco 3000.

Independent / non HDI







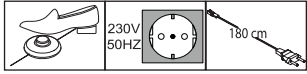

BLANK PRICE LIST

valid

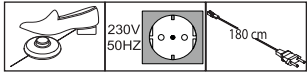
01.03.2023-31.08.2023

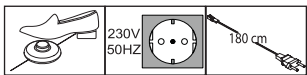
V.i.P.
by Wiemann

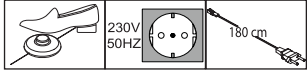
Unit accessories

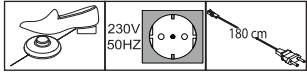
Description	Dimensions cm			Art. no.	GBP
	W	H	D		
 <p>LED Clip-On-Lights, silver</p> <p>This product contains light devices of energy efficiency class E</p>  <p>1 item 2 items 3 items</p> <p> Only in conjunction with PPT-Frame and cornice!</p>	60	1,5	4,5	980	
	60	1,5	4,5	981	
	60	1,5	4,5	982	
 <p>LED line light, silver</p> <p>This product contains light devices of energy efficiency class E</p>  <p>1 item 2 items 3 items</p>	60	6	19	983	
	60	6	19	984	
	60	6	19	985	
 <p>LED Clip-On-Lights, black</p> <p>This product contains light devices of energy efficiency class E</p>  <p>1 item 2 items 3 items</p> <p> Only in conjunction with PPT-Frame and cornice!</p>	60	1,5	4,5	880	
	60	1,5	4,5	881	
	60	1,5	4,5	882	
 <p>LED line light, black</p> <p>This product contains light devices of energy efficiency class E</p>  <p>1 item 2 items 3 items</p>	60	6	19	883	
	60	6	19	884	
	60	6	19	885	
 <p>LED top light, chrome</p> <p>This product contains light devices of energy efficiency class F</p>  <p>1 item 2 items 3 items</p>	5,5	3	22,5	970	
	5,5	3	22,5	971	
	5,5	3	22,5	972	

Passe-partout frames for sliding door wardrobes with or without lights

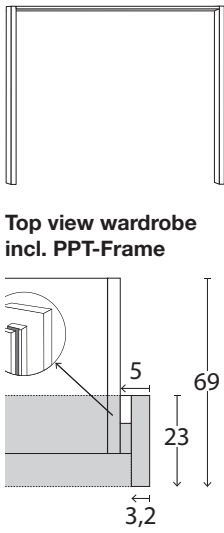
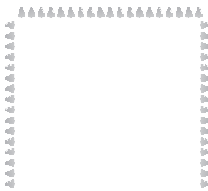
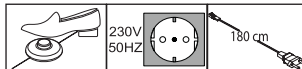
Description	Dimensions		Height 221 cm		Height 240 cm	
	W	D	Art. no.	GBP	Art. no.	GBP
 <p>Passe-partout frame, Width per side profile 3.2 cm, without lights</p> <ul style="list-style-type: none"> - for width 150 cm - for width 200 cm - for width 225 cm - for width 250 cm - for width 280 cm - for width 300 cm - for width 300 cm - for width 330 cm - for width 400 cm <p>Top view wardrobe incl. PPT-Frame</p> <p>Dimensions cm</p>	160	23	700		709	
	210	23	701		710	
	235	23	702		711	
	260	23	703		712	
	290	23	704		713	
	310	23	705		714	
	310	23	706		715	
	340	23	707		716	
	410	23	708		717	
	 <p>Surcharge for circumferential LED illumination (optional):</p> <ul style="list-style-type: none"> - for width 150 cm - for width 200 cm - for width 225 cm - for width 250 cm - for width 280 cm - for width 300 cm - for width 300 cm - for width 330 cm - for width 400 cm <p>This product contains light devices of energy efficiency class F</p> 	160	23	737		746
210		23	738		747	
235		23	739		748	
260		23	740		749	
290		23	741		750	
310		23	742		751	
310		23	743		752	
340		23	744		753	
410		23	745		754	
<p>Can not get assembled retrospectively!</p>						



Please note:

Passe-partout frame increases the wardrobe width to the dimensions indicated.

Monaco 3000.

Independent / non HDI

BLANK PRICE LIST

valid

01.03.2023-31.08.2023

V.i.P.
by Wiemann

Passe-partout frames for sliding door wardrobes with or without lights

Description	Dimensions		Height 221 cm		Height 240 cm	
	W	D	Art. no.	GBP	Art. no.	GBP
 <p>Passe-partout frame, Width per side profiles: 3.2 cm, with lights</p> <p>2 lights - for width 150 cm</p> <p>4 lights - for width 200 cm</p> <p>6 lights - for width 225 cm</p> <p>6 lights - for width 250 cm</p> <p>6 lights - for width 280 cm</p> <p>6 lights - for width 300 cm ⚠ - only for 3-doors wardrobes</p> <p>8 lights - for width 300 cm ⚠ - only for 4-doors wardrobes</p> <p>8 lights - for width 330 cm</p> <p>8 lights - for width 400 cm</p>						
	160	23	718		727	
	210	23	719		728	
	235	23	720		729	
	260	23	721		730	
	290	23	722		731	
	310	23	723		732	
	310	23	724		733	
	340	23	725		734	
	410	23	726		736	

Top view wardrobe
incl. PPT-Frame

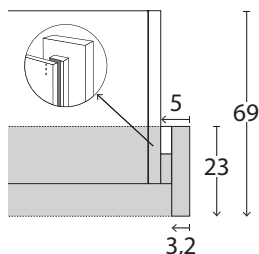

Dimensions cm

This product contains light devices
of energy efficiency class F

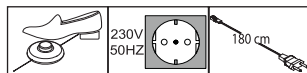

Please note:

Passe-partout frame increases the wardrobe width to the dimensions indicated.

Monaco 3000.

Independent / non HDI





BLANK PRICE LIST

valid



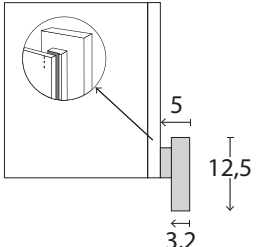

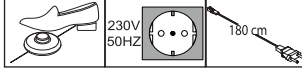

01.03.2023-31.08.2023

V.i.P.
by Wiemann

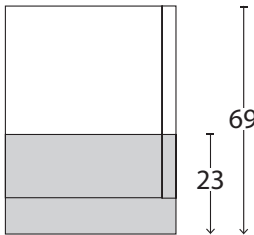
Additional elements for sliding door wardrobes

Description	Dimensions		Height 221 cm		Height 240 cm	
	W	D	Art. no.	GBP	Art. no.	GBP
 <p>Side profiles in carcass colour, in pairs</p> <p>Top view wardrobe incl. side profiles</p>  <p>Dimensions cm</p> <p> Suitable for Monaco 1000 + 2000 too!</p>	5	12,5	098		099	
 <p>Lights for side profiles</p> <p> Can not get assembled retrospectively! Useabl for side profiles and PPT-Frame without circumferential lights!</p> <p>This product contains light devices of energy efficiency class F</p> 	1,5	1	100		101	

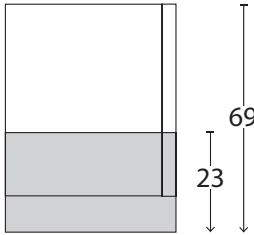
Cornices for sliding-door wardrobes with or without lights

Description	Dimensions cm			Art. no.	GBP
	W	H	D		
 <p>Cornice, without lights</p> <p>- for width 150 cm - for width 200 cm - for width 225 cm - for width 250 cm - for width 280 cm</p> <p>Top view wardrobe incl. cornice</p>  <p>Dimensions cm</p> <p>- for width 300 cm</p> <p> - only for 3-doors wardrobes</p> <p>- for width 300 cm</p> <p> - only for 4-doors wardrobes</p> <p>- for width 330 cm - for width 400 cm</p>	150 200 225 250 280 300 300 330 400	5 5 5 5 5 5 5 5 5	23 23 23 23 23 23 23 23	900 901 902 903 904 905 906 907 908	
 <p>Cornice, with lights</p> <p>2 lights - for width 150 cm 4 lights - for width 200 cm 6 lights - for width 225 cm 6 lights - for width 250 cm 6 lights - for width 280 cm</p> <p>Top view wardrobe incl. cornice</p>  <p>Dimensions cm</p> <p>6 lights - for width 300 cm</p> <p> - only for 3-doors wardrobes</p> <p>8 lights - for width 300 cm</p> <p> - only for 4-doors wardrobes</p> <p>8 lights - for width 330 cm 8 lights - for width 400 cm</p>	150 200 225 250 280 300 300 330 400	5 5 5 5 5 5 5 5	23 23 23 23 23 23 23 23	909 910 911 912 913 914 915 916 917	

This product contains light devices
of energy efficiency class F

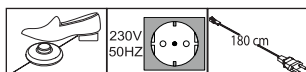

Monaco 3000.

Independent / non HDI

BLANK PRICE LIST

valid

01.03.2023-31.08.2023

V.i.P.









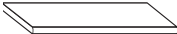
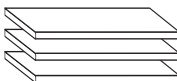

by Wiemann

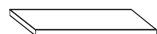
Unit accessories

Interior finish: silver grey striped



When ordering more than one accessory item for a compartment, please make sure that all accessories do not interfere with each other's function.

	Description	Dimensions cm			Art. no.	GBP
		W	H	D		
	<p>1 shelf</p> <p>- for compartment width 72.2 cm 1 item - for compartment width 80.1 cm 1 item - for compartment width 96.4 cm 1 item</p>	72,2 80,1 96,4	2,2 2,2 2,2	51,5 51,5 51,5	036 032 030	
	<p>3 shelves</p> <p>- for compartment width 72.2 cm 3 items - for compartment width 80.1 cm 3 items - for compartment width 96.4 cm 3 items</p>	72,2 80,1 96,4	2,2 2,2 2,2	51,5 51,5 51,5	038 033 031	
	<p>1 shelf for extended corner unit</p> <p>Not for use in conjunction with LED light screens!</p>	88	2,2	88	061	
	<p>1 shelf for extended walk-in corner unit</p>	72,2	2,2	51,5	046	
	<p>1 shelf for 90 degree corner unit with 2 hinged doors</p> <p>Not for use in conjunction with LED light screens!</p>	104,4	2,2	104,4	077	
	<p>1 shelf for 90 degree corner unit with bi-fold doors</p>	152,4	2,2	152,4	078	
	<p>Hanging rail</p> <p>- for compartment width 72.2 cm - for compartment width 80.1 cm - for compartment width 96.4 cm</p>	72,2 80,1 96,4	3 3 3	2 2 2	052 051 050	
	<p>1 hanging rail for extended corner unit</p> <p> Only for assembly under one shelf!</p>	95,8	3	2	082	
	<p>1 hanging rail for corner unit 90 degree with 2 hinged doors</p> <p> Only for assembly under one shelf!</p>	71,6	3	2	083	
	<p>1 hanging rail for corner unit 90 degree with bi-fold doors</p>	153	3	2	084	

Monaco 3000.

Independent / non HDI

BLANK PRICE LIST

valid

01.03.2023-31.08.2023

V.i.P.

by Wiemann

Unit accessories

Interior finish: silver grey striped



When ordering more than one accessory item for a compartment, please make sure that all accessories do not interfere with each other's function.

	Description	Dimensions cm			Art. no.	GBP
		W	H	D		
	Drawer insert with 2 drawers and glass front for hinged- and sliding-door wardrobes					
	- for compartment width 72.2 cm	72,2	41	52	068	
	- for compartment width 80.1 cm	80,1	41	52	069	
	- for compartment width 96.4 cm	96,4	41	52	070	
	Drawer insert with 2 drawers and wooden front for hinged- and sliding-door wardrobes, stackable and height adjustable					
	- for compartment width 72.2 cm	72,2	41	44	071	
	- for compartment width 80.1 cm	80,1	41	44	072	
	- for compartment width 96.4 cm	96,4	41	44	073	
	Drawer insert with 3 drawers and wooden front					
	- for compartment width 72.2 cm	72,2	89	51,5	023	
	- for compartment width 80.1 cm	80,1	89	51,5	024	
	- for compartment width 96.4 cm	96,4	89	51,5	064	
	Laundry shelf insert, consisting of 3 adjustable shelves, 1 hanging rail, 1 mid panel					
	- for compartment width 72.2 cm	72,2	137	51,5	025	
	- for compartment width 80.1 cm	80,1	137	51,5	026	
	- for compartment width 96.4 cm	96,4	137	51,5	066	
	For use on both sides (left or right)! Only to be placed on base plinth!					

Monaco 3000.

Independent / non HDI

BLANK PRICE LIST

valid

01.03.2023-31.08.2023





V.i.P.
by Wiemann

Unit accessories

Interior finish: silver grey striped

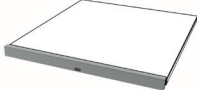

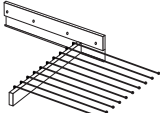
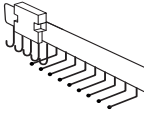
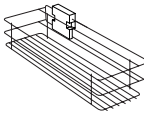
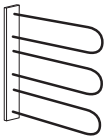
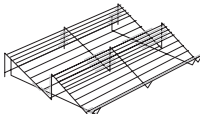
When ordering more than one accessory item for a compartment, please make sure that all accessories do not interfere with each other's function.

Description	Dimensions cm			Art. no.	GBP
	W	H	D		
 <p>LED Light screen for shelves</p> <p>- for compartment width 72.2 cm 1 item - for compartment width 80.1 cm 1 item - for compartment width 96.4 cm 1 item</p> <p>- for compartment width 72.2 cm 2 items - for compartment width 80.1 cm 2 items - for compartment width 96.4 cm 2 items</p> <p>- for compartment width 72.2 cm 3 items - for compartment width 80.1 cm 3 items - for compartment width 96.4 cm 3 items</p> <p>This product contains a light device of energy efficiency class F</p> <p> Not useable for walk-in corner units!</p>	72,2 80,1 96,4 72,2 80,1 96,4 72,2 80,1 96,4	3 3 3 3 3 3 3 3 3	1 1 1 1 1 1 1 1 1	002 016 011 003 017 013 004 018 015	
 <p>Trousers holder</p>	45	10	50	056	
 <p>Tie and belt pull-out</p>	7	19	45	059	
 <p>Utensil pull-out</p>	16	9	45	076	
 <p>Tie and belt rack</p>	30	27	9	042	
 <p>Shoe rack</p> <p>- for compartment width 96.4</p> <p> Not for bi-fold wardrobes!</p>	96	15	50	094	

Monaco 3000.

Independent / non HDI

BLANK PRICE LIST

valid

01.03.2023-31.08.2023



V.i.P.
by Wiemann

Unit accessories

Interior finish: silver grey striped

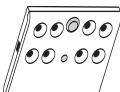
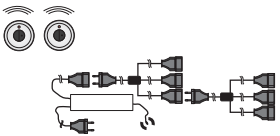

When ordering more than one accessory item for a compartment, please make sure that all accessories do not interfere with each other's function.

Description	Dimensions cm			Art. no.	GBP
	W	H	D		
 <p>Clothes lift for compartment width 72.3 - 96.4 cm</p>	100	85	14	081	
 <p>Fold-out interior mirror</p> <p> Only in conjunction with sliding-door wardrobes!</p> <p>Not for use in conjunction with LED light screens!</p>	36	173	2	080	
 <p>LED Wardrobe interior lights with motion detector, incl. rechargeable battery via USB</p> <p>1 item</p> <p>2 items</p> <p>3 items</p> <p>4 items</p>	10	2	10	006	
	10	2	10	007	
	10	2	10	008	
	10	2	10	009	
 <p>Radio receiver for lights with 2 transmitters</p> <p>for connection to up to 5 loads</p>	40	9	13	005	

Monaco 3000.

Sliding door wardrobes.

V.i.P.
by Wiemann



Independent / non HDI
BLANK PRICE LIST
 valid 01.03.2023-31.08.2023



Emission Tested
 Tested for Harmful
 Substances
 Regular Product
 Surveillance
 www.tuv.com
 ID 1111263053



Monaco 3000.

Sliding door wardrobes.

V.i.P.
by Wiemann



Independent / non HDI
BLANK PRICE LIST
valid 01.03.2023-31.08.2023



Emission Tested
Tested for Harmful
Substances
Regular Product
Surveillance
www.tuv.com
ID 1111263053



Monaco 3000.

Sliding door wardrobes.

V.i.P.
by Wiemann



Extended corner unit



Walk-in corner unit



Corner unit, 90 degree with hinged-doors



Corner unit, 90 degree with bi-fold doors

Independent / non HDI
BLANK PRICE LIST
valid

01.03.2023-31.08.2023



Emission Tested
Tested for Harmful
Substances
Regular Product
Surveillance
www.tuv.com
ID 1111263053

