

Monaco 1000.

Hinged-door wardrobes.

V.i.P.
by Wiemann



Independent / non HDI
BLANK PRICE LIST
 valid 01.03.2023-31.08.2023



Emission Tested
 Tested for Harmful
 Substances
 Regular Product
 Surveillance
 www.tuv.com
 ID 1111263053



Wardrobe system Monaco.

V.i.P.
by Wiemann

Monaco 1000

Hinged-door wardrobes



Monaco 2000

Wardrobes with bi-fold doors



Monaco 1000+2000

Functional units



Monaco 3000

Sliding door wardrobes



Monaco 4000

Beds + Occasional furniture



For these free standing wardrobes passepartout frames and cornices are available optionally either with our without lights (see accessories).

MONACO 1000 + 2000 - Hinged-doors-, Bi-fold-doors-, and Combi wardrobes

Grid width ca. 12.5cm - 2 heights

Wardrobe units with 2 outside panels

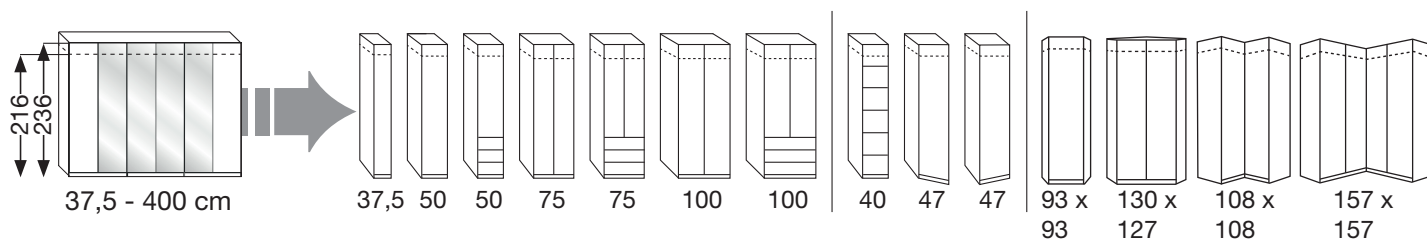

MONACO 1000 + 2000 - Wardrobe line ups (individually combined)

1. Example:

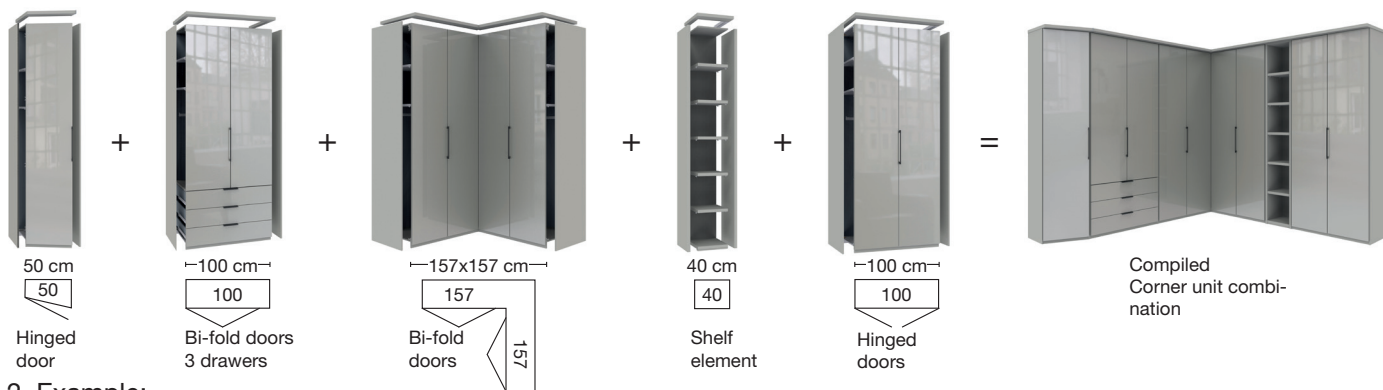

2. Example:

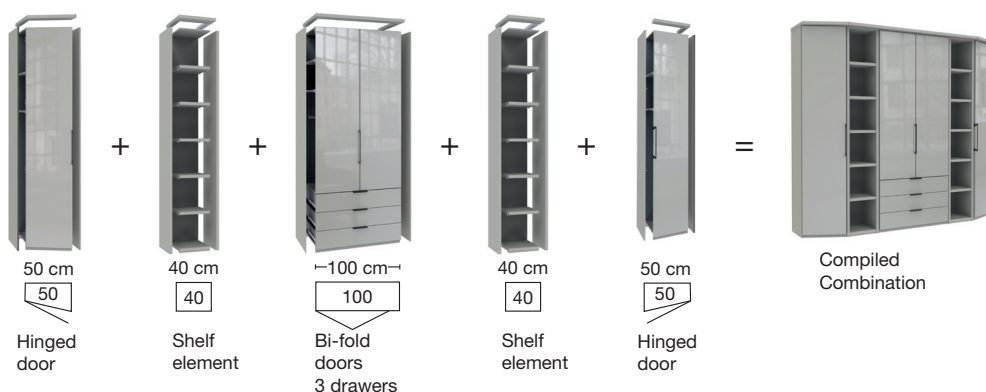

The single wardrobes include two end panels each and can get placed beside each other. For wardrobe line-ups, cornices are available. Please order one cornice per robe (lights are available as an option as well; see accessories)

Monaco 1000.









Hinged-door wardrobes.

V.i.P.
by Wiemann

Carcase and front colours

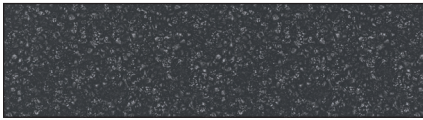
Please specify the exact colour combination of front and carcass colour for each order!

Designs:

 Handles in chrome 	 Handles in silver 	 Handles in slate 
 Model no. 228. Bianco oak finish	 Model no. 232. Bianco oak finish	 Model no. 239. Bianco oak finish
Model no. 229 White	Model no. 233 White	Model no. 242 White
Model no. 230 Pebble grey finish	Model no. 237 Pebble grey finish	Model no. 248 Pebble grey finish
Model no. 231 Champagne finish	Model no. 238 Champagne finish	Model no. 249 Champagne finish
Model no. 257 Graphite	Model no. 271 Graphite	Model no. 272 Graphite

furnplan

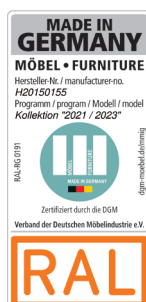

Monaco 1000.

Hinged-door wardrobes.

V.i.P.
by Wiemann

Front colours:

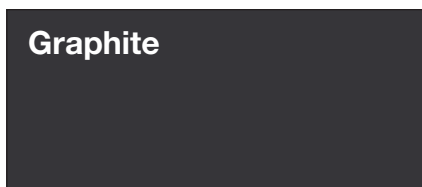
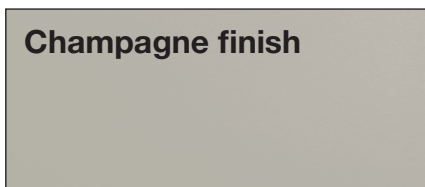
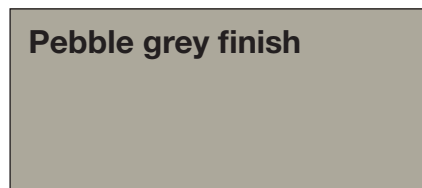

Glass fronts

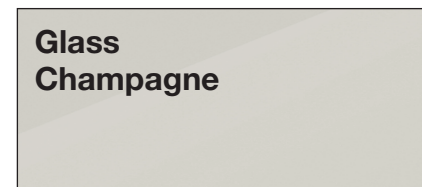
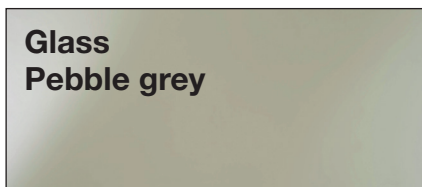

Mirror

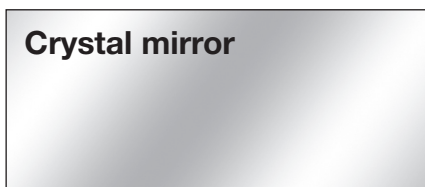

Interior colour

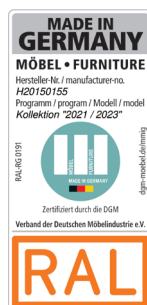

We reserve the right to color and model deviations or the correction of erroneous information. All measures are approximate cm.

Monaco 1000.

Hinged-door wardrobes.

V.i.P.
by Wiemann

Carcase width

Hinged-door wardrobes

Width	Side	Plinth	Side	Plinth	Side	Plinth	Side	Plinth	Side	Width effective
37,5	1,5	34,5	1,5							37,5 cm
50	1,5	47,5	1,5							50,5 cm
75	1,5	72,2	1,5							75,3 cm
100	1,5	96,4	1,5							99,4 cm
150	1,5	96,4	1,5	47,5	1,5					148,4 cm
150	1,5	72,2	1,5	72,2	1,5					148,9 cm
200	1,5	96,4	1,5	96,4	1,5					197,3 cm
225	1,5	72,2	1,5	72,2	1,5	72,2	1,5			222,6 cm
250	1,5	96,4	1,5	47,5	1,5	96,4	1,5			246,3 cm
250	1,5	47,5	1,5	72,2	1,5	72,2	1,5	47,5	1,5	246,9 cm
300	1,5	96,4	1,5	96,4	1,5	96,4	1,5			295,2 cm
300	1,5	72,2	1,5	72,2	1,5	72,2	1,5	72,2	1,5	294,8 cm
350	1,5	96,4	1,5	96,4	1,5	47,5	1,5	96,4	1,5	344,2 cm

Functional units

Width	Side	Plinth	Side	Plinth	Side	Plinth	Side	Plinth	Side	Width effective
50	1,5	47,5	1,5							50,5 cm
75	1,5	72,2	1,5							75,2 cm
100	1,5	96,4	1,5							99,4 cm
150	1,5	47,5	1,5	47,5	1,5	47,5	1,5			148,5 cm
150	1,5	72,2	1,5	72,2	1,5					148,9 cm
200	1,5	47,5	1,5	96,4	1,5	47,5	1,5			197,4 cm
225	1,5	72,2	1,5	72,2	1,5	72,2	1,5			222,6 cm
250	1,5	96,4	1,5	47,5	1,5	96,4	1,5			246,3 cm
250	1,5	47,5	1,5	72,2	1,5	72,2	1,5	47,5	1,5	246,9 cm
300	1,5	96,4	1,5	96,4	1,5	96,4	1,5			295,2 cm
300	1,5	47,5	1,5	96,4	1,5	96,4	1,5	47,5	1,5	295,3 cm
300	1,5	72,2	1,5	72,2	1,5	72,2	1,5	72,2	1,5	296,3 cm
350	1,5	96,4	1,5	96,4	1,5	47,5	1,5	96,4	1,5	344,2 cm



Passepartout frames available for each free standing wardrobe (not connected with others)!

Example: Hinged-door wardrobe W300cm + PPT-Frame / Cornices:

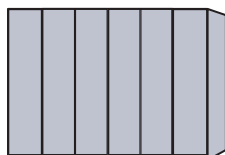

W 300 cm, H 216 cm
Front in carcass colour
= Art. no. 640

+



W 300 cm, H 220 cm
without lights
= Art. no. 851

OR



W 300 cm, H 3.2 cm
without lights
= Art. no. 935

Carcase widths - EXAMPLES**Wardrobe line ups (individually combined)**

Width	Side	Plinth	Side	Side	Plinth	Side	Side	Plinth	Side	Side	Plinth	Side	Side	Plinth	Side	Width effective
37,5	1,5	34,5	1,5													37,5 cm
50	1,5	47,5	1,5													50,5 cm
75	1,5	72,2	1,5													75,2 cm
88	1,5	47,5	1,5	1,5	34,5	1,5										88,0 cm
100	1,5	96,4	1,5													99,4 cm
113	1,5	72,2	1,5	1,5	34,5	1,5										112,7 cm
125	1,5	34,5	1,5	1,5	47,5	1,5	1,5	34,5	1,5							125,5 cm
138	1,5	47,5	1,5	1,5	34,5	1,5	1,5	47,5	1,5							138,5 cm
150	1,5	96,4	1,5	1,5	47,5	1,5										149,9 cm
150	1,5	72,2	1,5	1,5	72,2	1,5										150,4 cm
150	1,5	47,5	1,5	1,5	47,5	1,5	1,5	47,5	1,5							151,5 cm
163	1,5	72,2	1,5	1,5	47,5	1,5	1,5	34,5	1,5							163,2 cm
176	1,5	47,5	1,5	1,5	72,2	1,5	1,5	47,5	1,5							176,2 cm
188	1,5	72,2	1,5	1,5	34,5	1,5	1,5	72,2	1,5							187,9 cm
200	1,5	96,4	1,5	1,5	96,4	1,5										198,8 cm
212	1,5	96,4	1,5	1,5	72,2	1,5	1,5	34,5	1,5							212,1 cm
226	1,5	72,2	1,5	1,5	72,2	1,5	1,5	72,2	1,5							225,6 cm
236	1,5	96,4	1,5	1,5	34,5	1,5	1,5	96,4	1,5							236,3 cm
250	1,5	96,4	1,5	1,5	47,5	1,5	1,5	96,4	1,5							249,3 cm
250	1,5	72,2	1,5	1,5	96,4	1,5	1,5	72,2	1,5							249,8 cm
250	1,5	72,2	1,5	1,5	47,5	1,5	1,5	47,5	1,5	1,5	72,2	1,5				251,4 cm
263	1,5	72,2	1,5	1,5	72,2	1,5	1,5	34,5	1,5	1,5	72,2	1,5				263,1 cm
274	1,5	96,4	1,5	1,5	72,2	1,5	1,5	96,4	1,5							274,0 cm
287	1,5	96,4	1,5	1,5	47,4	1,5	1,5	34,5	1,5	1,5	96,4	1,5				286,7 cm
300	1,5	96,4	1,5	1,5	47,5	1,5	1,5	47,5	1,5	1,5	96,4	1,5				299,8 cm
300	1,5	96,4	1,5	1,5	96,4	1,5	1,5	96,4	1,5							298,2 cm
300	1,5	72,2	1,5	1,5	72,2	1,5	1,5	72,2	1,5	1,5	72,2	1,5				300,8 cm
312	1,5	96,4	1,5	1,5	72,2	1,5	1,5	34,5	1,5	1,5	96,4	1,5				311,5 cm
325	1,5	96,4	1,5	1,5	72,2	1,5	1,5	47,5	1,5	1,5	96,4	1,5				324,5 cm
338	1,5	72,2	1,5	1,5	72,2	1,5	1,5	72,2	1,5	1,5	72,2	1,5	1,5	34,5	1,5	338,3 cm
350	1,5	96,4	1,5	1,5	96,4	1,5	1,5	47,5	1,5	1,5	96,4	1,5				348,7 cm
373	1,5	96,4	1,5	1,5	96,4	1,5	1,5	72,2	1,5	1,5	96,4	1,5				373,4 cm
386	1,5	96,4	1,5	1,5	96,4	1,5	1,5	47,5	1,5	1,5	34,5	1,5	1,5	96,4	1,5	386,2 cm
400	1,5	96,4	1,5	1,5	96,4	1,5	1,5	96,4	1,5	1,5	96,4	1,5				397,6 cm



Cornices are only available for each individual wardrobe in a wardrobe line up (combined wardrobes)!

Example: Hinged-door wardrobe W263cm + Cornices:



W 100 cm,
H 216 cm
= Art. no. 348

+



W 75 cm,
H 216 cm
= Art. no. 261

+



Width 50
cm,
H 216 cm
= Art. no.
200/205

+



W 37.5 cm,
H 216 cm
= Art. no.
016/021

+



W 100 cm,
= Art. no. 928

+



W 75 cm,
= Art. no. 927

+



Width 50 cm,
= Art. no. 927

+



W 37.5 cm,
= Art. no. 964

Monaco 1000.

Independent / non HDI

BLANK PRICE LIST

valid

01.03.2023-31.08.2023



V.i.P.
by Wiemann

Hinged-door wardrobes W 37.5 cm without cornice

Interior:

2 shelves, 1 clothes rail per compartment

All hinged-doors incl. cushioned hinges

Description	Dimensions		Height 216 cm		Height 236 cm	
	W	D	Art. no.	GBP	Art. no.	GBP
<div style="display: flex; align-items: center;"> <div style="border: 1px solid black; padding: 2px; margin-right: 10px;">34,5</div> <div style="margin-right: 20px;">Door hinged on left</div> </div>						
<div style="display: flex; align-items: center;">   </div>	1 door - Front in carcass colour	37,5	58	016		034
	1 door - Front in glass white	37,5	58	017		035
	1 door - Front in glass pebble grey	37,5	58	018		037
	1 door - Front in glass champagne	37,5	58	019		039
	1 door - Front in crystal mirror	37,5	58	020		040
<div style="display: flex; align-items: center;">   </div>	Art. no. 016	Art. no. 018	Art. no. 019	Art. no. 020		
<div style="display: flex; align-items: center;"> <div style="border: 1px solid black; padding: 2px; margin-right: 10px;">34,5</div> <div style="margin-right: 20px;">Door hinged on right</div> </div>						
<div style="display: flex; align-items: center;">   </div>	1 door - Front in carcass colour	37,5	58	021		041
	1 door - Front in glass white	37,5	58	022		043
	1 door - Front in glass pebble grey	37,5	58	024		044
	1 door - Front in glass champagne	37,5	58	032		045
	1 door - Front in crystal mirror	37,5	58	033		051
<div style="display: flex; align-items: center;">   </div>	Art. no. 021	Art. no. 024	Art. no. 032	Art. no. 033		
<div style="display: flex; align-items: center;">   </div>	Art. no. 032	Art. no. 033				

Monaco 1000.

Independent / non HDI

BLANK PRICE LIST

valid

01.03.2023-31.08.2023























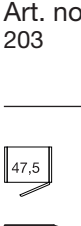



V.i.P.
by Wiemann

Hinged-door wardrobes W 50 cm without cornice

Interior:

2 shelves, 1 clothes rail per compartment

All hinged-doors incl. cushioned hinges

Description	Dimensions		Height 216 cm		Height 236 cm	
	W	D	Art. no.	GBP	Art. no.	GBP
 Door hinged on left						
  1 door - Front in carcass colour	50	58	200		210	
  1 door - Front in glass white	50	58	201		211	
  1 door - Front in glass pebble grey	50	58	202		212	
  1 door - Front in glass champagne	50	58	203		213	
  1 door - Front in crystal mirror	50	58	204		214	
  Art. no. 200 Art. no. 202						
  Art. no. 203 Art. no. 204						
 Door hinged on right						
  1 door - Front in carcass colour	50	58	205		215	
  1 door - Front in glass white	50	58	206		224	
  1 door - Front in glass pebble grey	50	58	207		225	
  1 door - Front glass champagne	50	58	208		226	
  1 door - Front in crystal mirror	50	58	209		227	
  Art. no. 205 Art. no. 207						
  Art. no. 208 Art. no. 209						

Monaco 1000.

Independent / non HDI

BLANK PRICE LIST

valid

01.03.2023-31.08.2023

V.i.P.





 by Wiemann

Combi wardrobes, W 50 cm without cornice

Interior:

2 shelves, 1 clothes rail per compartment

All hinged-doors incl. cushioned hinges

Description	Dimensions		Height 216 cm		Height 236 cm	
	W	D	Art. no.	GBP	Art. no.	GBP
 Door hinged on left, 3 drawers 50 cm						
1 door - Front in carcass colour	50	58	228		244	
1 door - Drawers in carcass colour 1 mirrored door	50	58	229		245	
 Art. no. 228	1 door - Front in glass white	50	58	230		246
 Art. no. 053	1 door - Doors glass white Drawers in carcass colour	50	58	053		057
	1 door - Drawers glass white 1 mirrored door	50	58	231		248
 Art. no. 232	1 door - Front in glass pebble	50	58	232		249
	1 door - Doors glass pebble grey Drawers in carcass colour	50	58	054		058
	1 door - Drawers glass pebble grey 1 mirrored door	50	58	233		250
 Art. no. 235	1 door - Front in glass champagne	50	58	234		251
	1 door - Doors glass champagne Drawers in carcass colour	50	58	055		060
	1 door - Drawers glass champagne 1 mirrored door	50	58	235		252

Monaco 1000.

Independent / non HDI

BLANK PRICE LIST

valid

01.03.2023-31.08.2023

V.i.P.









by Wiemann

Combi wardrobes, W 50 cm without cornice

Interior:

2 shelves, 1 clothes rail per compartment

All hinged-doors incl. cushioned hinges

Description	Dimensions		Height 216 cm		Height 236 cm	
	W	D	Art. no.	GBP	Art. no.	GBP
 Door hinged on right, 3 drawers 50 cm						
 1 door - Front in carcass colour	50	58	236		253	
1 door - Drawers in carcass colour 1 mirrored door	50	58	237		254	
 Art. no. 237						
1 door - Front in glass white	50	58	238		255	
 1 door - Doors glass white Drawers in carcass colour	50	58	061		065	
1 door - Drawers glass white 1 mirrored door	50	58	239		256	
 Art. no. 238						
1 door - Front in glass pebble	50	58	240		257	
 1 door - Doors glass pebble grey Drawers in carcass colour	50	58	062		067	
1 door - Drawers glass pebble grey 1 mirrored door	50	58	241		258	
 Art. no. 062						
 1 door - Front in glass champa-	50	58	242		259	
1 door - Doors glass champagne Drawers in carcass colour	50	58	063		068	
1 door - Drawers glass champagne 1 mirrored door	50	58	243		260	
 Art. no. 242						

Monaco 1000.

Independent / non HDI

BLANK PRICE LIST

valid

01.03.2023-31.08.2023

V.i.P.
by Wiemann

Hinged-door wardrobes, W 75 cm without cornice

Interior:

2 shelves, 1 clothes rail per compartment

All hinged-doors incl. cushioned hinges

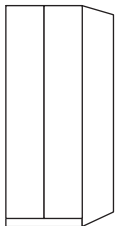
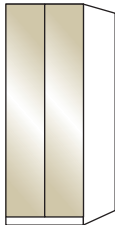
Description	Dimensions		Height 216 cm		Height 236 cm	
	W	D	Art. no.	GBP	Art. no.	GBP
						
						
2 doors - Front in carcass colour	75	58	261		271	
2 doors - Front glass white	75	58	262		272	
2 doors - Front glass pebble grey	75	58	263		273	
2 doors - Front glass champagne	75	58	264		274	
2 doors - Front crystal mirror	75	58	265		275	
						
Art. no. 261						
Art. no. 264						

Monaco 1000.

Independent / non HDI

BLANK PRICE LIST

valid

01.03.2023-31.08.2023

V.i.P.

by Wiemann

Combi wardrobes, W 75 cm without cornice

Interior:

2 shelves, 1 clothes rail per compartment

All hinged-doors incl. cushioned hinges

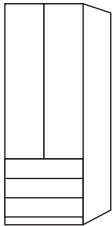
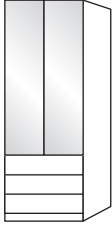
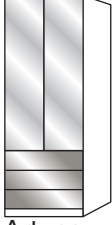
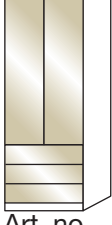
Description	Dimensions		Height 216 cm		Height 236 cm	
	W	D	Art. no.	GBP	Art. no.	GBP
 3 drawers 75 cm						
 2 doors - Front in carcass colour	75	58	281		297	
2 doors - Drawers in carcass colour 2 mirrored doors	75	58	282		298	
 2 doors - Front glass white	75	58	283		299	
2 doors - Doors glass white Drawers in carcass colour	75	58	139		142	
2 doors - Drawers glass white 2 mirrored doors	75	58	284		304	
 2 doors - Front glass pebble grey	75	58	285		305	
2 doors - Doors glass pebble grey Drawers in carcass colour	75	58	140		143	
2 doors - Drawers glass pebble grey 2 mirrored doors	75	58	286		306	
 2 doors - Front glass champagne	75	58	287		307	
2 doors - Doors glass champagne Drawers in carcass colour	75	58	141		144	
2 doors - Drawers glass champagne 2 mirrored doors	75	58	288		308	

Monaco 1000.

Independent / non HDI

BLANK PRICE LIST

valid

01.03.2023-31.08.2023

V.i.P.
by Wiemann

Hinged-door wardrobes, W 100 cm without cornice

Interior:

2 shelves, 1 clothes rail per compartment

All hinged-doors incl. cushioned hinges

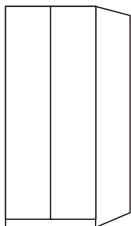
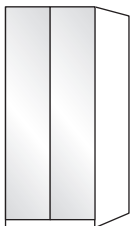
Description	Dimensions		Height 216 cm		Height 236 cm	
	W	D	Art. no.	GBP	Art. no.	GBP
 96,4						
 Art. no. 348	2 doors	- Front in carcass colour	100	58	348	358
	2 doors	- Front glass white	100	58	349	359
	2 doors	- Front glass pebble grey	100	58	350	360
	2 doors	- Front glass champagne	100	58	351	361
	2 doors	- Front crystal mirror	100	58	352	362
 Art. no. 349						

Monaco 1000.

Independent / non HDI

BLANK PRICE LIST

valid

01.03.2023-31.08.2023

V.i.P.

by Wiemann

Combi wardrobe, W 100 cm without cornice

Interior:

2 shelves, 1 clothes rail per compartment

All hinged-doors incl. cushioned hinges

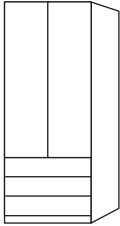
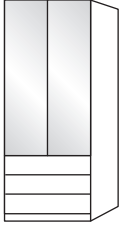
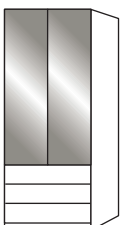
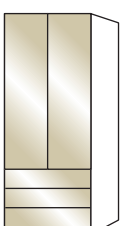
Description	Dimensions		Height 216 cm		Height 236 cm	
	W	D	Art. no.	GBP	Art. no.	GBP
 3 drawers 100 cm						
 2 doors - Front in carcass colour	100	58	368		384	
2 doors - Drawers in carcass colour 2 mirrored doors	100	58	369		385	
 2 doors - Front glass white	100	58	370		386	
2 doors - Doors glass white Drawers in carcass colour	100	58	152		155	
2 doors - Drawers glass white 2 mirrored doors	100	58	371		387	
 2 doors - Front glass pebble grey	100	58	372		388	
2 doors - Doors glass pebble grey Drawers in carcass colour	100	58	153		156	
2 doors - Drawers glass pebble grey 2 mirrored doors	100	58	373		389	
 2 doors - Front glass champagne	100	58	374		390	
2 doors - Doors glass champagne Drawers in carcass colour	100	58	154		157	
2 doors - Drawers glass champagne 2 mirrored doors	100	58	375		391	

Monaco 1000.

Independent / non HDI

BLANK PRICE LIST

valid

01.03.2023-31.08.2023

V.i.P.

by Wiemann

Hinged-door wardrobes, W 150 cm without cornice

Interior:

2 shelves, 1 clothes rail per compartment

All hinged-doors incl. cushioned hinges

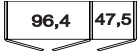
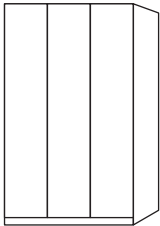
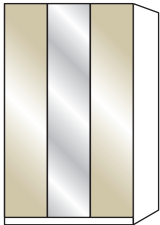
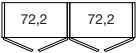
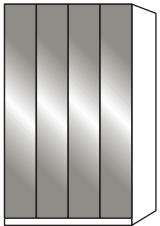
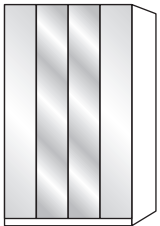
Description	Dimensions		Height 216 cm		Height 236 cm	
	W	D	Art. no.	GBP	Art. no.	GBP
						
	3 doors	- Front in carcass colour	150	58	400	416
	3 doors	- Front in glass white	150	58	401	417
	3 doors	- Front in glass pebble grey	150	58	402	418
	3 doors	- Front in glass champagne	150	58	403	419
Art. no. 400						
	1 centre mirrored door					
	3 doors	- Front in carcass colour	150	58	404	420
	3 doors	- Front in glass white	150	58	405	421
	3 doors	- Front in glass pebble grey	150	58	406	422
	3 doors	- Front in glass champagne	150	58	407	423
Art. no. 407						
						
	4 doors	- Front in carcass colour	150	58	408	424
	4 doors	- Front in glass white	150	58	409	425
	4 doors	- Front in glass pebble grey	150	58	410	426
	4 doors	- Front in glass champagne	150	58	411	427
Art. no. 410						
	2 centre mirrored doors					
	4 doors	- Front in carcass colour	150	58	412	428
	4 doors	- Front in glass white	150	58	413	429
	4 doors	- Front in glass pebble grey	150	58	414	430
	4 doors	- Front in glass champagne	150	58	415	431
Art. no. 413						

Monaco 1000.

Independent / non HDI

BLANK PRICE LIST

valid

01.03.2023-31.08.2023

V.i.P.

by Wiemann

Combi wardrobe, W 150 cm without cornice

Interior:

2 shelves, 1 clothes rail per compartment

All hinged-doors incl. cushioned hinges

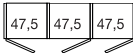
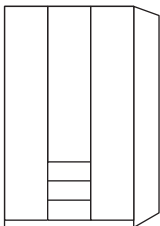
Description	Dimensions		Height 216 cm		Height 236 cm	
	W	D	Art. no.	GBP	Art. no.	GBP
 3 drawers 50 cm, in centre						
 3 doors - Front in carcase colour	150	58	432		448	
3 doors - Front in carcase colour 1 mirrored door	150	58	433		449	
3 doors - Front in glass white	150	58	434		450	
3 doors - Doors glass white Drawers in carcase colour	150	58	164		167	
3 doors - Front glass white 1 mirrored door	150	58	435		451	
3 doors - Front in glass pebble grey	150	58	436		452	
3 doors - Doors glass pebble grey Drawers in carcase colour	150	58	165		168	
3 doors - Front glass pebble grey 1 mirrored door	150	58	437		453	
3 doors - Front in glass champagne	150	58	438		454	
3 doors - Doors glass champagne Drawers in carcase colour	150	58	166		169	
3 doors - Front glass champagne 1 mirrored door	150	58	439		455	

Monaco 1000.

Independent / non HDI

BLANK PRICE LIST

valid

01.03.2023-31.08.2023

V.i.P.

 by Wiemann

Combi wardrobe, W 150 cm without cornice

Interior:

2 shelves, 1 clothes rail per compartment

All hinged-doors incl. cushioned hinges

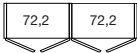
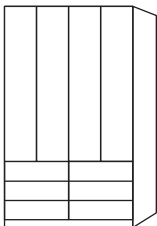
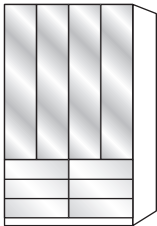
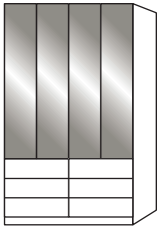
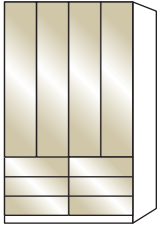
Description	Dimensions		Height 216 cm		Height 236 cm	
	W	D	Art. no.	GBP	Art. no.	GBP
 6 drawers à 75 cm						
 4 doors - Front in carcass colour	150	58	440		456	
4 doors - Drawers in carcass colour 4 mirrored doors	150	58	441		457	
4 doors - Front in glass white	150	58	442		458	
4 doors - Doors glass white Drawers in carcass colour	150	58	170		173	
4 doors - Drawers glass white 4 mirrored doors	150	58	443		459	
 4 doors - Front in glass pebble grey	150	58	444		460	
4 doors - Doors glass pebble grey Drawers in carcass colour	150	58	171		183	
4 doors - Drawers glass pebble grey 4 mirrored doors	150	58	445		461	
 4 doors - Front in glass champagne	150	58	446		462	
4 doors - Doors glass champagne Drawers in carcass colour	150	58	172		184	
4 doors - Drawers glass champagne 4 mirrored doors	150	58	447		463	
 Art. no. 446						

Monaco 1000.

Independent / non HDI

BLANK PRICE LIST

valid

01.03.2023-31.08.2023

V.i.P.
by Wiemann

Hinged-door wardrobes, W 200 cm without cornice

Interior:

2 shelves, 1 clothes rail per compartment

All hinged-doors incl. cushioned hinges

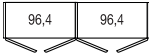
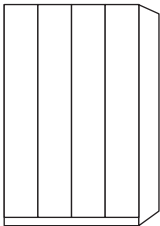
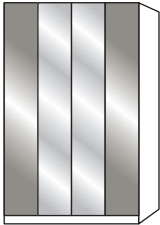
Description	Dimensions		Height 216 cm		Height 236 cm	
	W	D	Art. no.	GBP	Art. no.	GBP
						
	4 doors	- Front in carcass colour	200	58	512	528
	4 doors	- Front in glass white	200	58	513	529
	4 doors	- Front in glass pebble grey	200	58	514	530
	4 doors	- Front in glass champagne	200	58	515	531
Art. no. 512						
	2 centre mirrored doors					
	4 doors	- Front in carcass colour	200	58	516	532
	4 doors	- Front in glass white	200	58	517	533
	4 doors	- Front in glass pebble grey	200	58	518	534
	4 doors	- Front in glass champagne	200	58	519	535
Art. no. 518						

Monaco 1000.

Independent / non HDI

BLANK PRICE LIST

valid

01.03.2023-31.08.2023

V.i.P.

by Wiemann

Combi wardrobe, W 200 cm without cornice

Interior:

2 shelves, 1 clothes rail per compartment

All hinged-doors incl. cushioned hinges

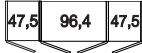
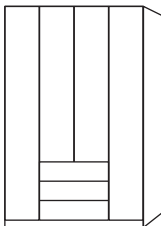
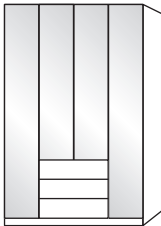
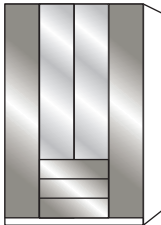
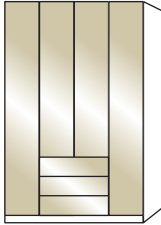
Description	Dimensions		Height 216 cm		Height 236 cm	
	W	D	Art. no.	GBP	Art. no.	GBP
 3 drawers 100 cm						
 4 doors - Front in carcass colour	200	58	544		560	
4 doors - Front in carcass colour 2 mirrored doors	200	58	545		561	
4 doors - Front in glass white Art. no. 544	200	58	546		562	
 4 doors - Doors glass white Drawers in carcass colour	200	58	185		188	
4 doors - Front glass white 2 mirrored doors	200	58	547		563	
Art. no. 185						
 4 doors - Front in glass pebble grey	200	58	548		564	
4 doors - Doors glass pebble grey Drawers in carcass colour	200	58	186		189	
4 doors - Front glass pebble grey 2 mirrored doors	200	58	549		565	
Art. no. 549						
 4 doors - Front in glass champagne	200	58	550		566	
4 doors - Doors glass champagne Drawers in carcass colour	200	58	187		190	
4 doors - Front glass champagne 2 mirrored doors	200	58	551		567	
Art. no. 550						

Monaco 1000.

Independent / non HDI

BLANK PRICE LIST

valid

01.03.2023-31.08.2023

V.i.P.
by Wiemann

Hinged-door wardrobes, W 225 cm without cornice

Interior:

2 shelves, 1 clothes rail per compartment

All hinged-doors incl. cushioned hinges

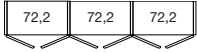
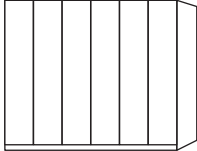
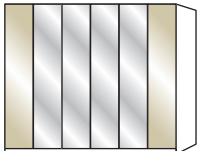
Description	Dimensions		Height 216 cm		Height 236 cm	
	W	D	Art. no.	GBP	Art. no.	GBP
						
 Art. no. 520	6 doors	- Front in carcass colour	225	58	520	536
	6 doors	- Front in glass white	225	58	521	537
	6 doors	- Front in glass pebble grey	225	58	522	538
	6 doors	- Front in glass champagne	225	58	523	539
 Art. no. 527	4 mirrored doors in centre					
	6 doors	- Front in carcass colour	225	58	524	540
	6 doors	- Front in glass white	225	58	525	541
	6 doors	- Front in glass pebble grey	225	58	526	542
	6 doors	- Front in glass champagne	225	58	527	543

Monaco 1000.

Independent / non HDI

BLANK PRICE LIST

valid

01.03.2023-31.08.2023

V.i.P.







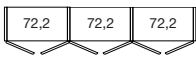
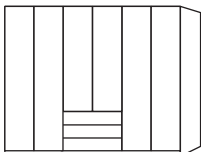
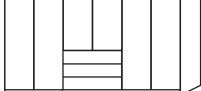

by Wiemann

Combi wardrobe, W 225 cm without cornice

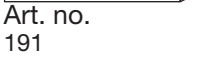
Interior:

2 shelves, 1 clothes rail per compartment

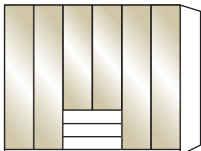
All hinged-doors incl. cushioned hinges

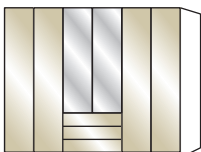
Description	Dimensions		Height 216 cm		Height 236 cm	
	W	D	Art. no.	GBP	Art. no.	GBP
 3 drawers 75 cm						
 6 doors - Front in carcass colour	225	58	552		568	
 6 doors - Front in carcass colour 2 mirrored doors	225	58	553		569	
Art. no. 552						
 6 doors - Front in glass white	225	58	554		570	
 6 doors - Doors glass white Drawers in carcass colour	225	58	191		194	
Art. no. 191						
 6 doors - Front glass white 2 mirrored doors	225	58	555		571	
 6 doors - Front in glass pebble grey	225	58	556		572	
 6 doors - Doors glass pebble grey Drawers in carcass colour	225	58	192		195	
Art. no. 556						
 6 doors - Front glass pebble grey 2 mirrored doors	225	58	557		573	
 6 doors - Front in glass champagne	225	58	558		574	
 6 doors - Doors glass champagne Drawers in carcass colour	225	58	193		196	
Art. no. 193						
 6 doors - Front glass champagne 2 mirrored doors	225	58	559		575	
Art. no. 559						

Monaco 1000.

Independent / non HDI

BLANK PRICE LIST

valid

01.03.2023-31.08.2023

V.i.P.
by Wiemann

Hinged-door wardrobes, W 250 cm without cornice

Interior:

2 shelves, 1 clothes rail per compartment

All hinged-doors incl. cushioned hinges

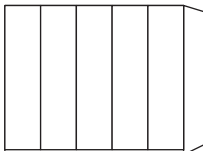
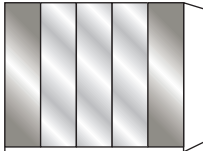
Description	Dimensions		Height 216 cm		Height 236 cm	
	W	D	Art. no.	GBP	Art. no.	GBP
						
	5 doors	- Front in carcass colour	250	58	576	592
	5 doors	- Front in glass white	250	58	577	593
	5 doors	- Front in glass pebble grey	250	58	578	594
Art. no. 576	5 doors	- Front in glass champagne	250	58	579	595
	3 mirrored doors in centre					
	5 doors	- Front in carcass colour	250	58	580	596
Art. no. 582	5 doors	- Front glass white	250	58	581	597
	5 doors	- Front glass pebble grey	250	58	582	598
	5 doors	- Front glass champagne	250	58	583	599
	3 glass doors in centre, Exterior doors in carcass colour					
	5 doors	- Front in glass white	250	58	197	342
Art. no. 247	5 doors	- Front in glass pebble grey	250	58	198	343
	5 doors	- Front in glass champagne	250	58	247	345

Monaco 1000.

Independent / non HDI

BLANK PRICE LIST

valid

01.03.2023-31.08.2023

V.i.P.



 by Wiemann

Combi wardrobe, W 250 cm without cornice

Interior:

2 shelves, 1 clothes rail per compartment

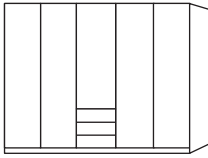
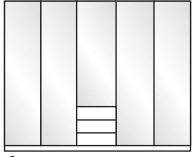
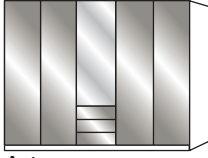
All hinged-doors incl. cushioned hinges

Description	Dimensions		Height 216 cm		Height 236 cm	
	W	D	Art. no.	GBP	Art. no.	GBP
 3 drawers 50 cm						
 5 doors - Front in carcass colour	250	58	608		624	
5 doors - Front in carcass colour 1 mirrored door	250	58	609		625	
Art. no. 608						
 5 doors - Front in glass white	250	58	610		626	
5 doors - Doors glass white Drawers in carcass colour	250	58	199		218	
5 doors - Front glass white 1 mirrored door	250	58	611		627	
Art. no. 199						
 5 doors - Front in glass pebble grey	250	58	612		628	
5 doors - Doors glass pebble grey Drawers in carcass colour	250	58	216		219	
5 doors - Front glass pebble grey 1 mirrored door	250	58	613		629	
Art. no. 613						
 5 doors - Front in glass champagne	250	58	614		630	
5 doors - Doors glass champagne Drawers in carcass colour	250	58	217		220	
5 doors - Front glass champagne 1 mirrored door	250	58	615		631	
Art. no. 614						

Monaco 1000.

Independent / non HDI

BLANK PRICE LIST

valid

01.03.2023-31.08.2023

V.i.P.

by Wiemann

Hinged-door wardrobes, W 250 cm without cornice

Interior:

2 shelves, 1 clothes rail per compartment

All hinged-doors incl. cushioned hinges

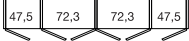
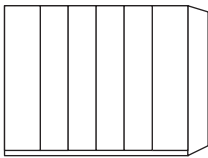
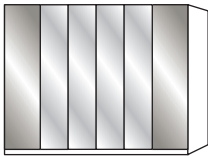
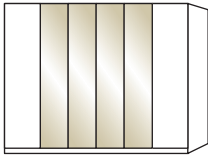
Description	Dimensions		Height 216 cm		Height 236 cm	
	W	D	Art. no.	GBP	Art. no.	GBP
						
 Art. no. 584	6 doors - Front in carcass colour	250	58	584		600
	6 doors - Front in glass white	250	58	585		601
	6 doors - Front in glass pebble grey	250	58	586		602
	6 doors - Front in glass champagne	250	58	587		603
 Art. no. 590	4 mirrored doors in centre					
	6 doors - Front in carcass colour	250	58	588		604
	6 doors - Front in glass white	250	58	589		605
	6 doors - Front in glass pebble grey	250	58	590		606
	6 doors - Front in glass champagne	250	58	591		607
 Art. no. 223	4 glass doors in centre, Exterior doors in carcass colour					
	6 doors - Front in glass white	250	58	221		309
	6 doors - Front in glass pebble grey	250	58	222		310
	6 doors - Front in glass champagne	250	58	223		311

Monaco 1000.

Independent / non HDI

BLANK PRICE LIST

valid

01.03.2023-31.08.2023

V.i.P.









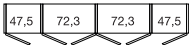
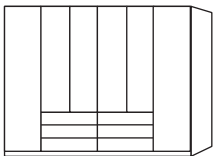
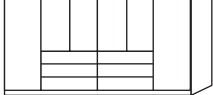
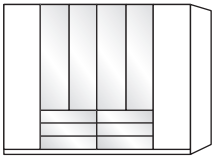

by Wiemann

Combi wardrobe, W 250 cm without cornice

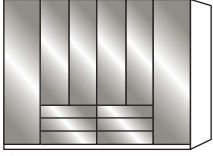
Interior:

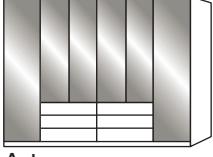
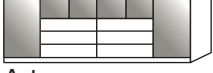
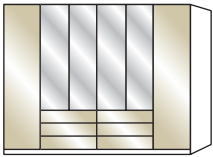
2 shelves, 1 clothes rail per compartment

All hinged-doors incl. cushioned hinges

Description	Dimensions		Height 216 cm		Height 236 cm	
	W	D	Art. no.	GBP	Art. no.	GBP
 6 drawers à 75 cm						
 6 doors - Front in carcasse colour	250	58	616		632	
 6 doors - Front in carcasse colour, 4 mirrored doors	250	58	617		633	
Art. no. 616						
 6 doors - Front in glass white	250	58	618		634	
 6 doors - Front glass white, Exterior doors in carcasse colour	250	58	312		318	
Art. no. 312						
 6 doors - Doors glass white, Drawers in carcasse colour	250	58	313		319	
 6 doors - Front glass white, 4 mirrored doors	250	58	619		635	
 6 doors - Front in glass pebble grey	250	58	620		636	
 6 doors - Front glass pebble grey, Exterior doors in carcasse colour	250	58	314		320	
Art. no. 620						
 6 doors - Doors glass pebble grey, Drawers in carcasse colour	250	58	315		321	
 6 doors - Front glass pebble grey, 4 mirrored doors	250	58	621		637	
Art. no. 315						
 6 doors - Front in glass champagne	250	58	622		638	
 6 doors - Front glass champagne Exterior doors in carcasse colour	250	58	316		322	
Art. no. 623						
 6 doors - Doors glass champagne Drawers in carcasse colour	250	58	317		323	
 6 doors - Front glass champagne 4 mirrored doors	250	58	623		639	

Monaco 1000.

Independent / non HDI

BLANK PRICE LIST

valid

01.03.2023-31.08.2023

V.i.P.
by Wiemann

Hinged-door wardrobes, W 300 cm without cornice

Interior:

2 shelves, 1 clothes rail per compartment

All hinged-doors incl. cushioned hinges

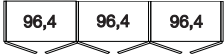
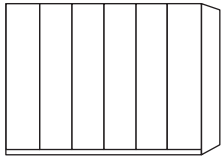
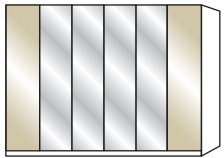
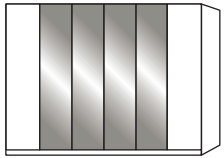
Description	Dimensions		Height 216 cm		Height 236 cm	
	W	D	Art. no.	GBP	Art. no.	GBP
						
	6 doors	- Front in carcass colour	300	58	640	656
	6 doors	- Front in glass white	300	58	641	657
	6 doors	- Front in glass pebble grey	300	58	642	658
Art. no. 640	6 doors	- Front in glass champagne	300	58	643	659
	4 mirrored doors in centre					
	6 doors	- Front in carcass colour	300	58	644	660
Art. no. 647	6 doors	- Front in glass white	300	58	645	661
	6 doors	- Front in glass pebble grey	300	58	646	662
	6 doors	- Front in glass champagne	300	58	647	663
	4 glass doors in centre, Exterior doors in carcass colour					
Art. no. 325	6 doors	- Front in glass white	300	58	324	327
	6 doors	- Front in glass pebble grey	300	58	325	328
	6 doors	- Front in glass champagne	300	58	326	329

Monaco 1000.

Independent / non HDI

BLANK PRICE LIST

valid

01.03.2023-31.08.2023

V.i.P.







by Wiemann

Combi wardrobe, W 300 cm without cornice

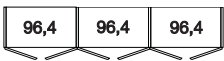
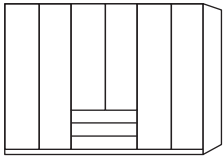
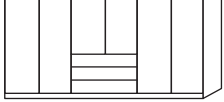
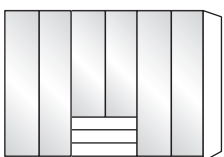
Interior:

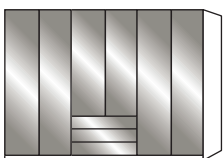
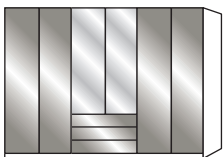
2 shelves, 1 clothes rail per compartment

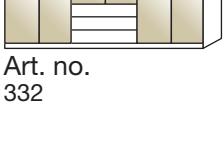
All hinged-doors incl. cushioned hinges

Description	Dimensions		Height 216 cm		Height 236 cm	
	W	D	Art. no.	GBP	Art. no.	GBP
 3 drawers 100 cm						
 6 doors - Front in carcass colour	300	58	672		688	
 6 doors - Front in carcass colour 2 mirrored doors	300	58	673		689	
Art. no. 672						
 6 doors - Front in glass white	300	58	674		690	
 6 doors - Doors glass white Drawers in carcass colour	300	58	330		333	
Art. no. 330						
 6 doors - Front glass white 2 mirrored doors	300	58	675		691	
 6 doors - Front in glass pebble grey	300	58	676		692	
Art. no. 676						
 6 doors - Doors glass pebble grey Drawers in carcass colour	300	58	331		334	
 6 doors - Front glass pebble grey 2 mirrored doors	300	58	677		693	
Art. no. 677						
 6 doors - Front in glass champagne	300	58	678		694	
 6 doors - Doors glass champagne Drawers in carcass colour	300	58	332		335	
Art. no. 332						
 6 doors - Front glass champagne 2 mirrored doors	300	58	679		695	

Monaco 1000.

Independent / non HDI

BLANK PRICE LIST

valid

01.03.2023-31.08.2023

V.i.P.









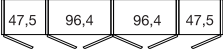
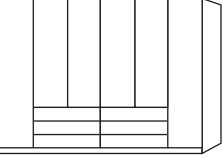
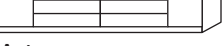
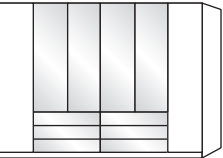

by Wiemann

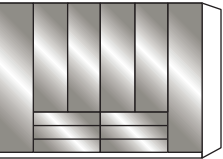
Combi wardrobe, W 300 cm without cornice

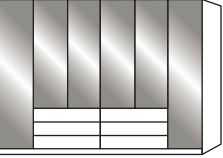
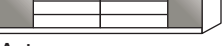
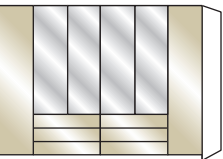
Interior:

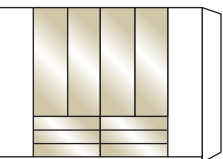
2 shelves, 1 clothes rail per compartment

All hinged-doors incl. cushioned hinges

Description	Dimensions		Height 216 cm		Height 236 cm	
	W	D	Art. no.	GBP	Art. no.	GBP
 6 drawers à 100 cm						
 6 doors - Front in carcasse colour	300	58	680		696	
 6 doors - Front in carcasse colour, 4 mirrored doors	300	58	681		697	
Art. no. 680						
 6 doors - Front in glass white	300	58	682		698	
 6 doors - Front glass white, Exterior doors in carcasse colour	300	58	336		469	
Art. no. 336						
 6 doors - Doors glass white, Drawers in carcasse colour	300	58	464		470	
 6 doors - Front glass white, 4 mirrored doors	300	58	683		699	
Art. no. 684						
 6 doors - Front in glass pebble grey	300	58	684		700	
 6 doors - Front glass pebble grey, Exterior doors in carcasse colour	300	58	465		471	
Art. no. 466						
 6 doors - Doors glass pebble grey, Drawers in carcasse colour	300	58	466		472	
 6 doors - Front glass pebble grey, 4 mirrored doors	300	58	685		701	
Art. no. 687						
 6 doors - Front in glass champagne	300	58	686		702	
 6 doors - Front glass champagne Exterior doors in carcasse colour	300	58	467		473	
Art. no. 467						
 6 doors - Doors glass champagne Drawers in carcasse colour	300	58	468		474	
 6 doors - Front glass champagne 4 mirrored doors	300	58	687		703	

Monaco 1000.

Independent / non HDI

BLANK PRICE LIST

valid

01.03.2023-31.08.2023

V.i.P.
by Wiemann

Hinged-door wardrobes, W 300 cm without cornice

Interior:

2 shelves, 1 clothes rail per compartment

All hinged-doors incl. cushioned hinges

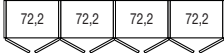
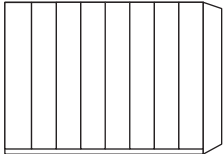
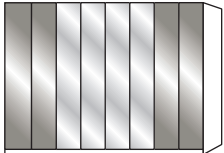
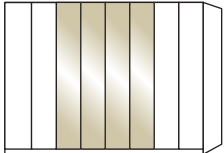
Description	Dimensions		Height 216 cm		Height 236 cm	
	W	D	Art. no.	GBP	Art. no.	GBP
						
	8 doors	- Front in carcass colour	300	58	704	712
	8 doors	- Front in glass white	300	58	705	713
	8 doors	- Front in glass pebble grey	300	58	706	714
Art. no. 704	8 doors	- Front in glass champagne	300	58	707	715
	4 mirrored doors in centre					
	8 doors	- Front in carcass colour	300	58	708	716
Art. no. 710	8 doors	- Front in glass white	300	58	709	717
	8 doors	- Front in glass pebble grey	300	58	710	718
	8 doors	- Front in glass champagne	300	58	711	719
	4 glass doors in centre, Exterior doors in carcass colour					
	8 doors	- Front glass white	300	58	475	478
Art. no. 477	8 doors	- Front glass pebble grey	300	58	476	479
	8 doors	- Front glass champagne	300	58	477	480

Monaco 1000.

Independent / non HDI

BLANK PRICE LIST

valid

01.03.2023-31.08.2023

V.i.P.



 by Wiemann

Combi wardrobe, W 300 cm without cornice

Interior:

2 shelves, 1 clothes rail per compartment

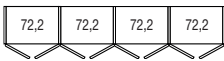
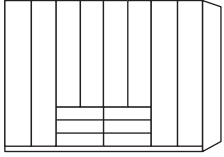
All hinged-doors incl. cushioned hinges

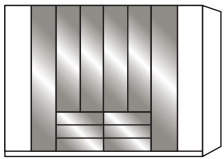
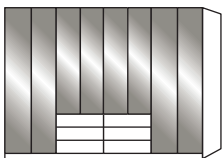
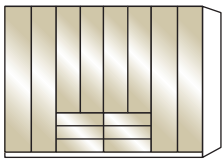
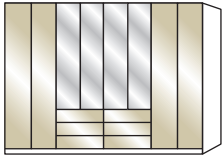
Description	Dimensions		Height 216 cm		Height 236 cm	
	W	D	Art. no.	GBP	Art. no.	GBP
 6 drawers à 75 cm						
 8 doors - Front in carcasse colour 8 doors - Front in carcasse colour, 4 mirrored doors	300	58	720		728	
Art. no. 720						
 8 doors - Front in glass white 8 doors - Front glass white, Exterior doors in carcasse colour	300	58	722		730	
Art. no. 482						
 8 doors - Doors glass white, Drawers in carcasse colour 8 doors - Front glass white, 4 mirrored doors	300	58	482		488	
Art. no. 483						
 8 doors - Front in glass pebble grey 8 doors - Front glass pebble grey, Exterior doors in carcasse colour	300	58	724		732	
Art. no. 484						
 8 doors - Doors glass pebble grey, Drawers in carcasse colour 8 doors - Front glass pebble grey, 4 mirrored doors	300	58	484		490	
Art. no. 726						
 8 doors - Front in glass champagne 8 doors - Front glass champagne Exterior doors in carcasse colour	300	58	726		734	
Art. no. 727						
8 doors - Doors glass champagne Drawers in carcasse colour 8 doors - Front glass champagne 4 mirrored doors	300	58	485		491	
	300	58	486		492	
	300	58	727		735	

Monaco 1000.

Independent / non HDI

BLANK PRICE LIST

valid

01.03.2023-31.08.2023

V.i.P.
by Wiemann

Hinged-door wardrobes, W 350 cm without cornice

Interior:

2 shelves, 1 clothes rail per compartment

All hinged-doors incl. cushioned hinges

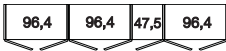
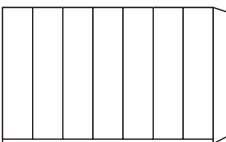
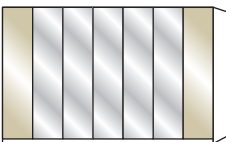
Description	Dimensions		Height 216 cm		Height 236 cm	
	W	D	Art. no.	GBP	Art. no.	GBP
						
 7 doors - Front in carcass colour	350	58	736		752	
7 doors - Front in glass white	350	58	737		753	
7 doors - Front in glass pebble grey	350	58	738		754	
7 doors - Front in glass champagne	350	58	739		755	
Art. no. 736						
 5 mirrored doors in centre						
7 doors - Front in carcass colour	350	58	740		756	
7 doors - Front in glass white	350	58	741		757	
7 doors - Front in glass pebble grey	350	58	742		758	
7 doors - Front in glass champagne	350	58	743		759	
Art. no. 743						

Monaco 1000.

Independent / non HDI

BLANK PRICE LIST

valid

01.03.2023-31.08.2023

V.i.P.







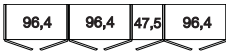
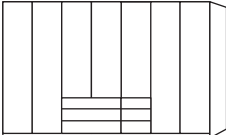

by Wiemann

Combi wardrobe, W 350 cm without cornice

Interior:

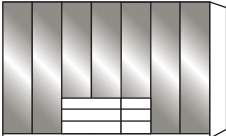
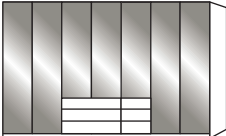
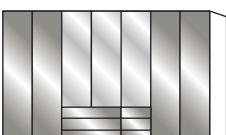
2 shelves, 1 clothes rail per compartment

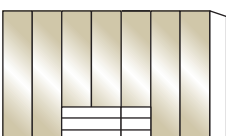
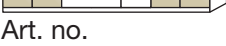
All hinged-doors incl. cushioned hinges

Description	Dimensions		Height 216 cm		Height 236 cm	
	W	D	Art. no.	GBP	Art. no.	GBP
 3 drawers à 100 cm, 3 drawers 50 cm						
 7 doors - Front in carcass colour Art. no. 300	350	58	300		500	
 7 doors - Front in carcass colour 3 mirrored doors Art. no. 301	350	58	301		501	
 7 doors - Front in glass white Art. no. 302	350	58	302		502	
 7 doors - Doors glass white Drawers in carcass colour Art. no. 303	350	58	303		503	
 7 doors - Front glass white 3 mirrored doors Art. no. 493	350	58	493		504	
 7 doors - Front in glass pebble grey Art. no. 495	350	58	494		505	
 7 doors - Doors glass pebble grey Drawers in carcass colour Art. no. 496	350	58	495		506	
 7 doors - Front glass pebble grey 3 mirrored doors Art. no. 496	350	58	496		507	
 7 doors - Front in glass champagne Art. no. 498	350	58	497		508	
 7 doors - Doors glass champagne Drawers in carcass colour Art. no. 498	350	58	498		509	
 7 doors - Front glass champagne 3 mirrored doors Art. no. 499	350	58	499		510	

Monaco 1000.

Independent / non HDI

BLANK PRICE LIST

valid

01.03.2023-31.08.2023





V.i.P.
by Wiemann

Corner units without cornice

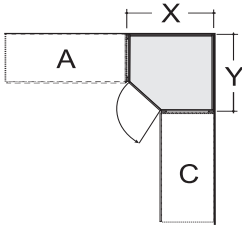

Not for use in conjunction with passe-partout frames!

For corner unit combinations including one or two sliding-door wardrobes please choose a corner unit of Monaco 3000!

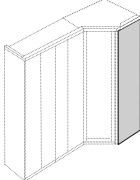
Description	Dimensions		Height 216 cm		Height 236 cm		
	W	D	Art. no.	GBP	Art. no.	GBP	
 <p>Extended corner unit</p> <p>Door hinged left:</p> <p>1 door - Front in carcass colour</p> <p>1 door - Front in glass white</p> <p>1 door - Front in glass pebble grey</p> <p>1 door - Front in glass champagne</p> <p>1 door - Front in crystal mirror</p>							
 <p>X = 93,3 cm</p> <p>Y = 93,3 cm</p>							
<p>Interior:</p> <p>2 shelves, 1 clothes rail per compartment</p> <p>All hinged-doors incl. cushioned hinges</p>							
 <p>Connection wardrobes of width 50 cm placed left to the extended corner wardrobe must be RHH only due to technical reasons!</p>							
 <p>End panel for extended corner unit, can be used on right and left</p> <p>Required with a final extended corner unit. If a corner unit stands separately, 2 outer sides are required.</p>							
<p>Not useable in conjunction with cornices!</p>							

Monaco 1000.

Independent / non HDI

BLANK PRICE LIST



valid

01.03.2023-31.08.2023

V.i.P.
by Wiemann

Corner units without cornice

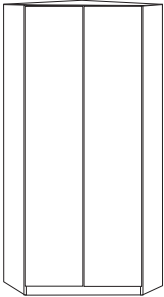
Not for use in conjunction with passe-partout frames!
For corner unit combinations including one or two sliding-door wardrobes please choose a corner unit of Monaco 3000!

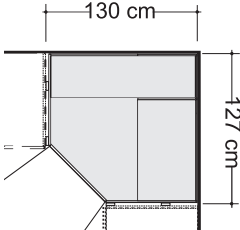
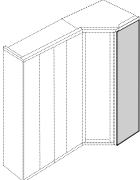
Description	Dimensions		Height 216 cm		Height 236 cm		
	W	D	Art. no.	GBP	Art. no.	GBP	
 <p>Walk-in corner unit with hinged-doors</p> <p>2 doors - Front in carcase colour</p> <p>2 doors - Front in glass white</p> <p>2 doors - Front in glass pebble grey</p> <p>2 doors - Front in glass champagne</p> <p>2 doors - Front in crystal mirror</p>  							
		130	127	799		809	
		130	127	800		810	
		130	127	801		811	
		130	127	802		812	
		130	127	803		813	
<p>Interior: W 72.2cm: 2 shelves, 1 hanging rail, W 125 cm: 5 shelves, Lights with motion detector</p> <p>All hinged-doors incl. cushioned hinges</p> <p>This product contains a light device of energy efficiency class G</p>							
 <p>End panel for walk-in corner unit, can be used on right and left</p> <p>Required if a corner unit is used on end. If a corner unit is mounted separately, 2 outer panels are required.</p>	56	1,5	090		091		
<p>Not useable in conjunction with cornices!</p>							

Monaco 1000.

Independent / non HDI

BLANK PRICE LIST

valid

01.03.2023-31.08.2023





V.i.P.
by Wiemann

Corner units without cornice

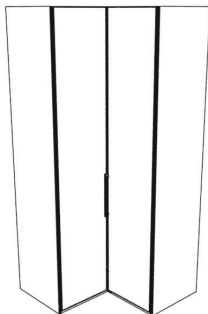

Not for use in conjunction with passe-partout frames!

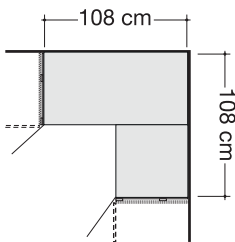
For corner unit combinations including one or two sliding-door wardrobes please choose a corner unit of Monaco 3000!

Description	Dimensions		Height 216 cm		Height 236 cm	
	W	D	Art. no.	GBP	Art. no.	GBP
 <p>Corner unit, 90 degree with 2 hinged doors inclusive end panels</p> <ul style="list-style-type: none"> - Front in carcass colour - Front glass white - Front glass pebble grey - Front glass champagne - Front crystal mirror 	108	108	968		992	
	108	108	969		993	
	108	108	989		994	
	108	108	990		995	
	108	108	991		996	
  <p>Interior: 2 shelves 105cm x 105cm, 2 hanging rails 71.5 cm</p> <p> Doors without cushioners!</p>						

Monaco 1000.

Independent / non HDI

BLANK PRICE LIST

valid

01.03.2023-31.08.2023



V.i.P.
by Wiemann

Corner units without cornice



Not for use in conjunction with passe-partout frames!

For corner unit combinations including one or two sliding-door wardrobes please choose a corner unit of Monaco 3000!

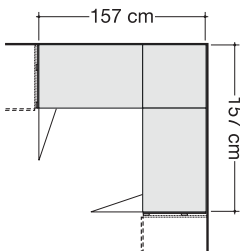
Description	Dimensions		Height 216 cm		Height 236 cm	
	W	D	Art. no.	GBP	Art. no.	GBP
 <p>Corner unit, 90 degree with bi-fold doors inclusive end panels</p> <ul style="list-style-type: none"> - Front in carcase colour - Front glass white - Front glass pebble grey - Front glass champagne - Front crystal mirror   <p>Interior: W 55.8 cm: 2 shelves W 96.4 cm: 4 shelves 2 hanging rails 152 cm</p>	157	157	814		819	
	157	157	815		820	
	157	157	816		821	
	157	157	817		822	
	157	157	818		823	

Monaco 1000.

Independent / non HDI

BLANK PRICE LIST

valid

01.03.2023-31.08.2023

V.i.P.
by Wiemann





End units with swing door, angled, without cornice

Interior:

4 adjustable shelves

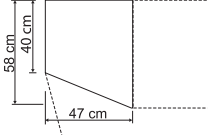
All hinged-doors incl. cushioned hinges

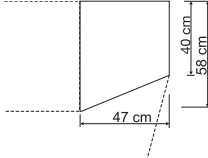
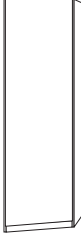
Not for use in conjunction with passe-partout frames!

Description	Dimensions		Height 216 cm		Height 236 cm	
	W	D	Art. no.	GBP	Art. no.	GBP
 <p>For placing on left:</p> <ul style="list-style-type: none"> - Front in carcase colour - Front glass white - Front glass pebble grey - Front glass champagne - Front crystal mirror  <p>Not useable for standing alone!</p> <p> Not for use in conjunction with sliding-door wardrobes!</p> <p>Not for use in conjunction with passe-partout frames!</p>						
	47	58	824		832	
	47	58	825		833	
	47	58	826		834	
	47	58	827		835	
	47	58	870		872	
 <p>For placing on right:</p> <ul style="list-style-type: none"> - Front in carcase colour - Front glass white - Front glass pebble grey - Front glass champagne - Front crystal mirror  <p>Not useable for standing alone!</p> <p> Not for use in conjunction with sliding-door wardrobes!</p> <p>Not for use in conjunction with passe-partout frames!</p>						
	47	58	828		836	
	47	58	829		837	
	47	58	830		838	
	47	58	831		839	
	47	58	871		886	

Monaco 1000.

Independent / non HDI

BLANK PRICE LIST

valid

01.03.2023-31.08.2023







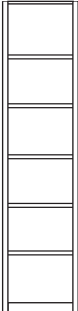

V.i.P.
by Wiemann

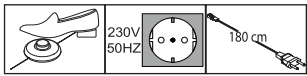
Shelf element without cornice

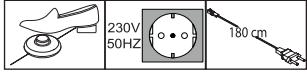
**Not for use in conjunction with passe-partout frames!**

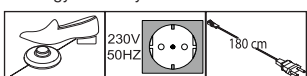
Description	Dimensions		Height 216 cm		Height 236 cm	
	W	D	Art. no.	GBP	Art. no.	GBP
 <p>Open shelf element in carcase colour, with 5 shelves</p>	40	36	840		841	

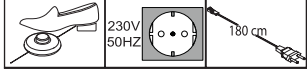
Unit accessories

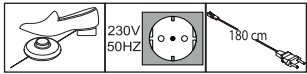
Description	Dimensions cm			Art. no.	GBP
	W	H	D		
 <p>LED Clip-On-Lights, silver</p> <p>1 item 2 items 3 items</p> <p>This product contains light devices of energy efficiency class E</p>  <p>Only in conjunction with PPT-Frame and cornice!</p>	60	6	19	980	
	60	6	19	981	
	60	6	19	982	
 <p>LED line light, silver</p> <p>1 item 2 items 3 items</p> <p>This product contains light devices of energy efficiency class E</p> 	60	6	19	983	
	60	6	19	984	
	60	6	19	985	
 <p>LED Clip-On-Lights, black</p> <p>1 item 2 items 3 items</p> <p>This product contains light devices of energy efficiency class E</p>  <p>Only in conjunction with PPT-Frame and cornice!</p>	60	6	19	880	
	60	6	19	881	
	60	6	19	882	
 <p>LED line light, black</p> <p>1 item 2 items 3 items</p> <p>This product contains light devices of energy efficiency class E</p> 	60	6	19	883	
	60	6	19	884	
	60	6	19	885	
 <p>LED top light, chrome</p> <p>1 item 2 items 3 items</p> <p>This product contains light devices of energy efficiency class F</p> 	5,5	3	22,5	794	
	5,5	3	22,5	795	
	5,5	3	22,5	796	

Monaco 1000.

Independent / non HDI

BLANK PRICE LIST

valid





01.03.2023-31.08.2023

V.i.P.
by Wiemann

Passe-partout frames without lights

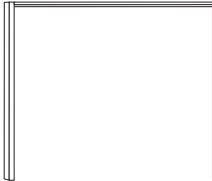

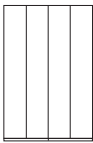
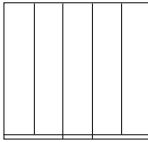
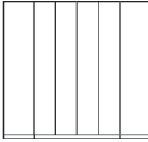

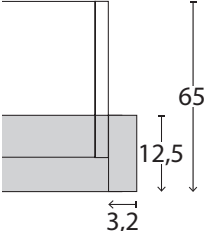
Useable only for single units!

Description	Dimensions		Height 220 cm		Height 240 cm	
	W	D	Art. no.	GBP	Art. no.	GBP
 Width per side profiles: 3.2 cm, without lights - for width 50 cm - for width 75 cm - for width 100 cm	56,4	12,5	842		856	
	81,4	12,5	843		857	
	106,4	12,5	844		858	
 - for width 150 cm - only for 3-doors wardrobes	156,4	12,5	845		859	
 - for width 150 cm - only for 4-doors wardrobes	156,4	12,5	846		860	
- for width 200 cm - for width 225 cm	206,4 231,4	12,5 12,5	847 848		861 862	
 - for width 250 cm - only for 5-doors wardrobes	256,4	12,5	849		863	
 - for width 250 cm - only for 6-doors wardrobes	256,4	12,5	850		864	
 - for width 300 cm - only for 6-doors wardrobes	306,4	12,5	851		865	
 - for width 300 cm - only for 8-doors wardrobes	306,4	12,5	852		866	
- for width 350 cm	356,4	12,5	853		867	
Top view wardrobe incl. PPT-Frame  Dimensions cm						

Circumferential LED illumination (optional)

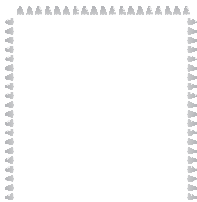
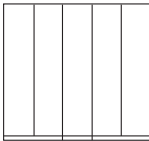

Useable only for single units!

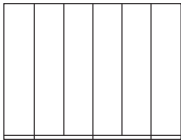
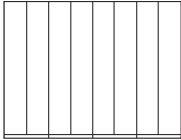
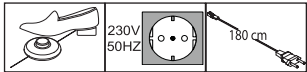
Description	Dimensions		Height 220 cm		Height 240 cm	
	W	D	Art. no.	GBP	Art. no.	GBP
 <p>Surcharge for circumferential LED illumination (optional):</p>						
- for width 100 cm	106,4	12,5	873		887	
- for width 150 cm - only for 3-doors wardrobes	156,4	12,5	874		888	
- for width 150 cm - only for 4-doors wardrobes	156,4	12,5	868		869	
- for width 200 cm	206,4	12,5	875		889	
- for width 225 cm	231,4	12,5	876		890	
 <td>- for width 250 cm - only for 5-doors wardrobes</td> <td>256,4</td> <td>12,5</td> <td>877</td> <td></td> <td>891</td>	- for width 250 cm - only for 5-doors wardrobes	256,4	12,5	877		891
 <td>- for width 250 cm - only for 6-doors wardrobes</td> <td>256,4</td> <td>12,5</td> <td>878</td> <td></td> <td>892</td>	- for width 250 cm - only for 6-doors wardrobes	256,4	12,5	878		892
 <td>- for width 300 cm - only for 6-doors wardrobes</td> <td>306,4</td> <td>12,5</td> <td>879</td> <td></td> <td>893</td>	- for width 300 cm - only for 6-doors wardrobes	306,4	12,5	879		893
 <td>- for width 300 cm - only for 8-doors wardrobes</td> <td>306,4</td> <td>12,5</td> <td>986</td> <td></td> <td>894</td>	- for width 300 cm - only for 8-doors wardrobes	306,4	12,5	986		894
- for width 350 cm	356,4	12,5	987		895	
<p>This product contains light devices of energy efficiency class F</p> 						

Monaco 1000.

Independent / non HDI

BLANK PRICE LIST

valid

01.03.2023-31.08.2023

V.i.P.
by Wiemann

Passe-partout frames with LED lights

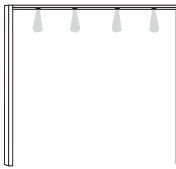
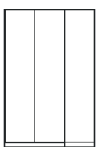
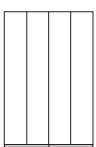
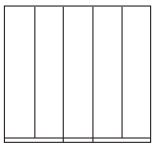
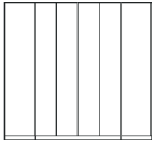
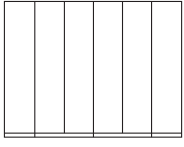
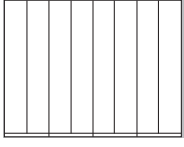
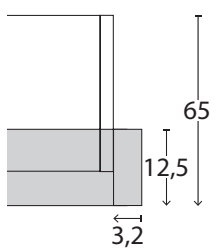
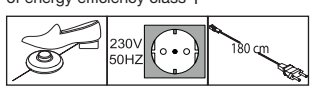

Useable only for single units!

Description	Dimensions		Height 220 cm		Height 240 cm	
	W	D	Art. no.	GBP	Art. no.	GBP
 Width per side profile 3.2 cm, with LED lights - for width 50 cm 1 light - for width 75 cm 2 lights - for width 100 cm 2 lights	56,4	12,5	898		912	
	81,4	12,5	899		913	
	106,4	12,5	900		914	
 - for width 150 cm 3 lights - only for 3-doors wardrobes	156,4	12,5	901		915	
 - for width 150 cm 4 lights - only for 4-doors wardrobes	156,4	12,5	902		916	
- for width 200 cm 4 lights - for width 225 cm 6 lights	206,4	12,5	903		917	
<td>231,4</td> <td>12,5</td> <td>904</td> <td></td> <td>918</td> <td></td>	231,4	12,5	904		918	
 - for width 250 cm 5 lights - only for 5-doors wardrobes	256,4	12,5	905		919	
 - for width 250 cm 6 lights - only for 6-doors wardrobes	256,4	12,5	906		920	
 - for width 300 cm 6 lights - only for 6-doors wardrobes	306,4	12,5	907		921	
 - for width 300 cm 8 lights - only for 8-doors wardrobes	306,4	12,5	908		922	
- for width 350 cm 7 lights	356,4	12,5	909		923	
Top view wardrobe incl. PPT-Frame  This product contains light devices of energy efficiency class F 						
Dimensions cm						

Monaco 1000.

Independent / non HDI

BLANK PRICE LIST

valid



01.03.2023-31.08.2023

V.i.P.
by Wiemann

Cornices without lights

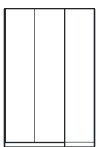
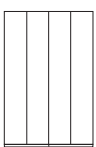
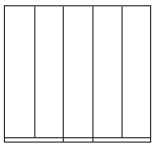
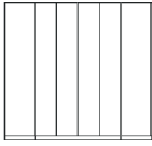
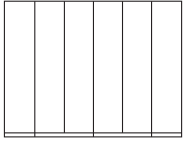

Please order matching (individual) cornices for each individual wardrobe (same width)!

Description	Dimensions cm			Art. no.	GBP
	W	H	D		
 <ul style="list-style-type: none"> - for width 37,5 cm - for width 50 cm - for width 75 cm - for width 100 cm 	37,5	3,2	12,5	964	
	50	3,2	12,5	926	
	75	3,2	12,5	927	
	100	3,2	12,5	928	
 <ul style="list-style-type: none"> - for width 150 cm - only for 3-doors wardrobes 	150	3,2	12,5	929	
 <ul style="list-style-type: none"> - for width 150 cm - only for 4-doors wardrobes 	150	3,2	12,5	930	
<ul style="list-style-type: none"> - for width 200 cm - for width 225 cm 	200	3,2	12,5	931	
	225	3,2	12,5	932	
 <ul style="list-style-type: none"> - for width 250 cm - only for 5-doors wardrobes 	250	3,2	12,5	933	
 <ul style="list-style-type: none"> - for width 250 cm - only for 6-doors wardrobes 	250	3,2	12,5	934	
 <ul style="list-style-type: none"> - for width 300 cm - only for 6-doors wardrobes 	300	3,2	12,5	935	
 <ul style="list-style-type: none"> - for width 300 cm - only for 8-doors wardrobes 	300	3,2	12,5	936	
<ul style="list-style-type: none"> - for width 350 cm 	350	3,2	12,5	937	
For corner units: <ul style="list-style-type: none"> - for extended corner unit - for walk-in corner unit - for 90 degree corner unit with hinged doors - for 90 degree corner unit with bi-fold doors 	65	3,2	12,5	940	
	114	3,2	12,5	941	
	108	3,2	12,5	965	
	157	3,2	12,5	942	
For end units: <ul style="list-style-type: none"> - for end unit left - for end unit right 	55,5	3,2	12,5	943	
	55,5	3,2	12,5	944	
<ul style="list-style-type: none"> - for shelf unit 	40	3,2	12,5	945	

Monaco 1000.

Independent / non HDI

BLANK PRICE LIST

valid

01.03.2023-31.08.2023

V.i.P.



by Wiemann

Cornices

for LED lights, the light is not included and has to be ordered separately

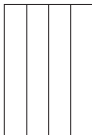
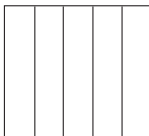
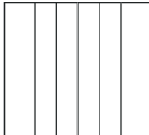
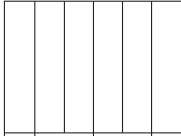
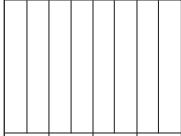

Please order matching (individual) cornices for each individual wardrobe (same width)!

Description	Dimensions cm			Art. no.	GBP
	W	H	D		
 <ul style="list-style-type: none"> - for width 37,5 cm 1 drill - for width 50 cm 1 drill - for width 75 cm 2 drills - for width 100 cm 2 drills 	37,5	3,2	12,5	966	
	50	3,2	12,5	946	
	75	3,2	12,5	947	
	100	3,2	12,5	948	
 <ul style="list-style-type: none"> - for width 150 cm 3 drills - only for 3-doors wardrobes 	150	3,2	12,5	949	
 <ul style="list-style-type: none"> - for width 150 cm 4 drills - only for 4-doors wardrobes 	150	3,2	12,5	950	
<ul style="list-style-type: none"> - for width 200 cm 4 drills - for width 225 cm 6 drills 	200	3,2	12,5	951	
	225	3,2	12,5	952	
 <ul style="list-style-type: none"> - for width 250 cm 5 drills - only for 5-doors wardrobes 	250	3,2	12,5	953	
 <ul style="list-style-type: none"> - for width 250 cm 6 drills - only for 6-doors wardrobes 	250	3,2	12,5	954	
 <ul style="list-style-type: none"> - for width 300 cm 6 drills - only for 6-doors wardrobes 	300	3,2	12,5	955	
 <ul style="list-style-type: none"> - for width 300 cm 8 drills - only for 8-doors wardrobes 	300	3,2	12,5	956	
<ul style="list-style-type: none"> - for width 350 cm 7 drills 	350	3,2	12,5	957	

Monaco 1000.

Independent / non HDI

BLANK PRICE LIST

valid

01.03.2023-31.08.2023



V.i.P.
by Wiemann

Cornices



for LED lights, the light is not included and has to be ordered separately



Please order matching (individual) cornices for each individual wardrobe (same width)!

Description	Dimensions cm			Art. no.	GBP
	W	H	D		
 <p>For corner units:</p> <ul style="list-style-type: none"> - for extended corner unit 1 drill - for walk-in corner unit 2 drills - for 90 degree corner unit 2 drills with hinged doors - for 90 degree corner unit 4 drills with bi-fold doors 					
 <p>Corner units with bevelling are not intended to end with a cornice. Please continue with another robe + cornice!</p>					
<p>For end units:</p> <ul style="list-style-type: none"> - for end unit left 1 drill - for end unit right 1 drill - for shelf unit 1 drill 					

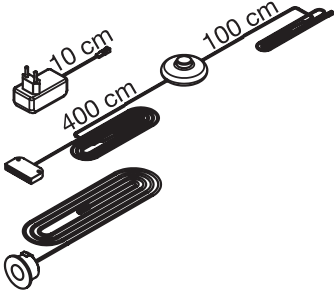
Lights kit for cornices

Description	Dimensions cm			Art. no.	GBP
	W	H	D		
<p>LED light kit consisting of: Foot switch, LED plug EVG with Wiring and LED spot light(s)</p>  <p>Maximum distance between outer spotlights:</p> <p>1 light –</p> <p>2 lights 360 cm</p> <p>3 lights 360 cm</p> <p>4 lights 360 cm</p> <p>5 lights 500 cm</p> <p>6 lights 500 cm</p> <p>7 lights 500 cm</p> <p>8 lights 500 cm</p> <p>9 lights 680 cm</p> <p>10 lights 680 cm</p>					
<p>This product contains light devices of energy efficiency class F</p> 					

Monaco 1000.

Independent / non HDI

BLANK PRICE LIST

valid

01.03.2023-31.08.2023

V.i.P.









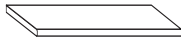
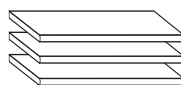

 by Wiemann

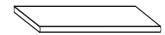
Unit accessories

Interior finish: silver grey striped



When ordering more than one accessory item for a compartment, please make sure that all accessories do not interfere with each other's function.

	Description	Dimensions cm			Art. no.	GBP
		W	H	D		
	1 shelf - for compartment width 34,5 cm 1 item - for compartment width 47.5 cm 1 item - for compartment width 72.2 cm 1 item - for compartment width 96.4 cm 1 item	34,5 47,5 72,2 96,4	2,2 2,2 2,2 2,2	51,5 51,5 51,5 51,5	026 028 036 030	
	3 shelves - for compartment width 34,5 cm 3 items - for compartment width 47.5 cm 3 items - for compartment width 72.2 cm 3 items - for compartment width 96.4 cm 3 items	34,5 47,5 72,2 96,4	2,2 2,2 2,2 2,2	51,5 51,5 51,5 51,5	027 029 038 031	
	1 adjustable shelf for end unit, angled Not for use in conjunction with LED light screens!	43	2,2	51,5	075	
	1 shelf for extended corner unit Not for use in conjunction with LED light screens!	88	2,2	88	073	
	1 shelf for extended walk-in corner unit	72,2	2,2	51,5	074	
	1 shelf for 90 degree corner unit with 2 hinged doors Not for use in conjunction with LED light screens!	104,4	2,2	104,4	077	
	1 shelf for 90 degree corner unit with bi-fold doors	152,4	2,2	152,4	078	
	Hanging rail - for compartment width 34,5 cm - for compartment width 47.5 cm - for compartment width 72.2 cm - for compartment width 96.4 cm	34,5 47,5 72,2 96,4	3 3 3 3	2 2 2 2	048 049 052 050	
	1 hanging rail for extended corner unit  Only for assembly under one shelf!	95,8	3	2	082	
	1 hanging rail for corner unit 90 degree with 2 hinged doors  Only for assembly under one shelf!	71,6	3	2	083	
	1 hanging rail for corner unit 90 degree with bi-fold doors	153	3	2	084	

Monaco 1000.

Independent / non HDI

BLANK PRICE LIST

valid



01.03.2023-31.08.2023

V.i.P.
by Wiemann

Unit accessories

Interior finish: silver grey striped

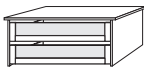
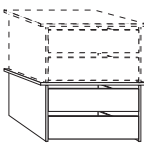
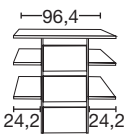
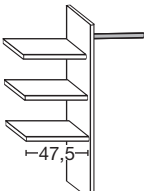
When ordering more than one accessory item for a compartment, please make sure that all accessories do not interfere with each other's function.

	Description	Dimensions cm			Art. no.	GBP
		W	H	D		
	Drawer insert with 2 drawers and glass front for hinged- and sliding-door wardrobes - for compartment width 72.2 cm - for compartment width 96.4 cm	72,2	41	52	069	
		96,4	41	52	070	
	Drawer insert with 2 drawers and wooden front for hinged- and sliding-door wardrobes, stackable and height adjustable - for compartment width 72.2 cm - for compartment width 96.4 cm	72,2	41	44	071	
		96,4	41	44	072	
 Art. no. 064	Drawer insert with 3 drawers and wooden front - for compartment width 96.4	96,3	89	51,5	064	
	Laundry insert, consisting of: 3 shelves W 47,5 cm, 1 hanging rail, 1 mid panel - for compartment width 72.2 cm - for compartment width 96.4 cm	72,2	137	51,5	025	
		96,4	137	51,5	066	
	For use on both sides (left or right)! Only to be placed on base plinth!					

Monaco 1000.

Independent / non HDI

BLANK PRICE LIST

valid

01.03.2023-31.08.2023





V.i.P.
by Wiemann

Unit accessories

Interior finish: silver grey striped

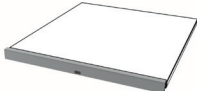

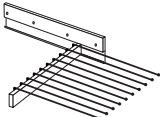
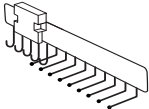
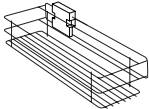
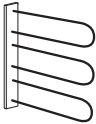
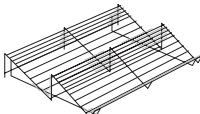
When ordering more than one accessory item for a compartment, please make sure that all accessories do not interfere with each other's function.

Description	Dimensions cm			Art. no.	GBP
	W	H	D		
 <p>LED Light screen for shelves</p> <p>- for compartment width 47.5 cm 1 item - for compartment width 72.2 cm 1 item - for compartment width 96.4 cm 1 item</p> <p>This product contains a light device of energy efficiency class F</p> <p>- for compartment width 47.5 cm 2 items - for compartment width 72.2 cm 2 items - for compartment width 96.4 cm 2 items</p> <p> Not useable for walk-in corner units!</p> <p>- for compartment width 47.5 cm 3 items - for compartment width 72.2 cm 3 items - for compartment width 96.4 cm 3 items</p>					
 <p>Trousers holder</p>	45	10	50	056	
 <p>Tie and belt pull-out</p>	7	19	45	059	
 <p>Utensil pull-out</p>	16	9	45	076	
 <p>Tie and belt rack</p>	30	27	9	042	
 <p>Shoe rack for unit compartment W 96.4 cm</p> <p> Not for bi-fold wardrobes!</p>	96	15	50	080	
 <p>Clothes lift for compartment width 72.3 - 96.4 cm</p>	100	85	14	081	

Monaco 1000.

Independent / non HDI

BLANK PRICE LIST

valid



01.03.2023-31.08.2023

V.i.P.
by Wiemann

Unit accessories

Interior finish: silver grey striped

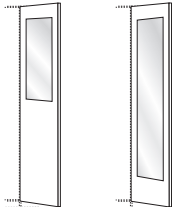
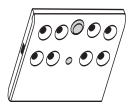
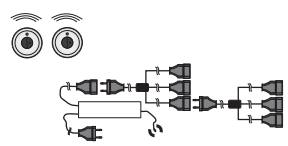
When ordering more than one accessory item for a compartment, please make sure that all accessories do not interfere with each other's function.

Description		Dimensions cm			Art. no.	GBP
		W	H	D		
	Interior mirror					
	! ATTENTION ! Only in combination with swing doors! For door width 50 cm!	36 36	80 173	1 1	046 047	
Art. no. 046	Art. no. 047					
	LED Wardrobe interior lights with motion detector , incl. rechargeable battery via USB					
1 item		10	2	10	006	
2 items		10	2	10	007	
3 items		10	2	10	008	
4 items		10	2	10	009	
	Radio receiver for lights with 2 transmitters for connection to up to 5 loads					
		40	9	13	005	
	165° hinge for hinged doors					
	6er-Set	1	1	1	339	
	 Without damping!					

Monaco 1000.

Hinged-door wardrobes.

V.i.P.
by Wiemann



Independent / non HDI
BLANK PRICE LIST
valid 01.03.2023-31.08.2023



Emission Tested
Tested for Harmful
Substances
Regular Product
Surveillance
www.tuv.com
ID 1111263053



Monaco 1000.

Hinged-door wardrobes.

V.i.P.
by Wiemann



Independent / non HDI
BLANK PRICE LIST
 valid 01.03.2023-31.08.2023



Emission Tested
 Tested for Harmful
 Substances
 Regular Product
 Surveillance
 www.tuv.com
 ID 1111263053



Monaco 1000.

Hinged-door wardrobes.

V.i.P.
by Wiemann



Independent / non HDI
BLANK PRICE LIST
valid 01.03.2023-31.08.2023



Emission Tested
Tested for Harmful
Substances
Regular Product
Surveillance
www.tuv.com
ID 1111263053



Monaco 1000.

Hinged-door wardrobes.

V.i.P.

by Wiemann



Independent / non HDI
BLANK PRICE LIST
 valid

01.03.2023-31.08.2023



Emission Tested
 Tested for Harmful
 Substances
 Regular Product
 Surveillance
 www.tuv.com
 ID 1111263053



Monaco 1000.

Hinged-door wardrobes.

V.i.P.
by Wiemann



Independent / non HDI
BLANK PRICE LIST
 valid 01.03.2023-31.08.2023



Emission Tested
 Tested for Harmful
 Substances
 Regular Product
 Surveillance
 www.tuv.com
 ID 1111263053



Monaco 1000.

Hinged-door wardrobes.

V.i.P.
by Wiemann



Independent / non HDI
BLANK PRICE LIST
 valid 01.03.2023-31.08.2023



Emission Tested
 Tested for Harmful
 Substances
 Regular Product
 Surveillance
 www.tuv.com
 ID 1111263053

