

Kos.

V.i.P.

by Wiemann



Independent / non HDI
BLANK PRICE LIST
 valid until **28.02.2025**



Emission Tested
 Tested for Harmful
 Substances
 Regular Product
 Surveillance
 www.tuv.com
 ID 1111263053



Carcase and front colours

Please specify the exact colour combination of front and carcase colour for each order!

Designs:

Carcase

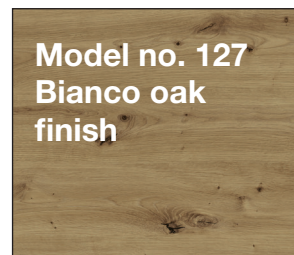
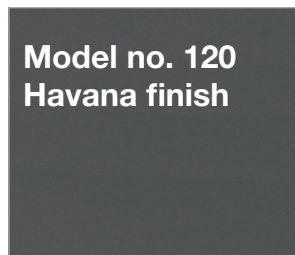
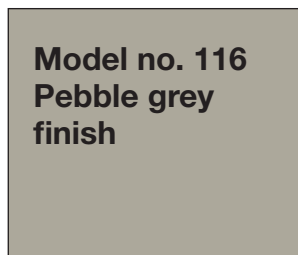
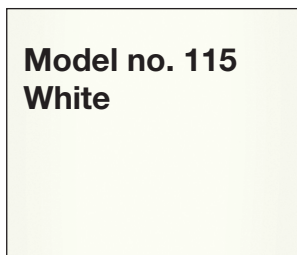

Glass fronts



Mirror

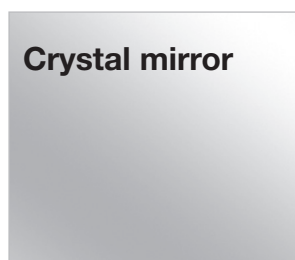

Interior colour

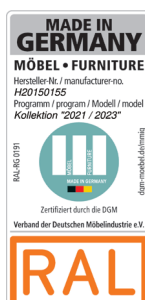

Kos.

V.i.P.

by Wiemann



Independent / non HDI
BLANK PRICE LIST
valid until **28.02.2025**



Emission Tested
Tested for Harmful
Substances
Regular Product
Surveillance
www.tuv.com
ID 1111263053



Kos.**V.i.P.**
by Wiemann**Carcase width****Sliding door wardrobes**

Width	Side	Plinth	Side	Plinth	Side	Plinth	Side	Plinth	Side			Width effective
200	1,5	96,4	1,5	96,4	1,5							197,3 cm
250	1,5	80,1	1,5	80,1	1,5	80,1	1,5					246,3 cm
280	1,5	96,4	1,5	80,1	1,5	96,4	1,5					278,9 cm
300	1,5	96,4	1,5	96,4	1,5	96,4	1,5					295,2 cm
330	1,5	80,1	1,5	80,1	1,5	80,1	1,5	80,1	1,5			327,9 cm
400	1,5	96,4	1,5	96,4	1,5	96,4	1,5	96,4	1,5			393,1 cm

Important instructions

We reserve the right to color and model deviations or the correction of erroneous information. All measures are approximate cm.

Kos.

Independent / non HDI



BLANK PRICE LIST

valid until **28.02.2025**

V.i.P.
by Wiemann

Sliding door wardrobes
Handles in carcase colour

Interior:
2 adjustable shelves, 1 clothes rail

Description	Dimensions cm		Height 217 cm		Height 236 cm	
	W	D	Art. no.	GBP	Art. no.	GBP
Front in glass white						
	2 doors	200	67	528		534
	3 doors	250	67	529		535
	3 doors	280	67	530		536
	3 doors	300	67	531		537
	- with synchronous opening					
	4 doors	330	67	532		538
	4 doors	400	67	533		539

Plinth partition

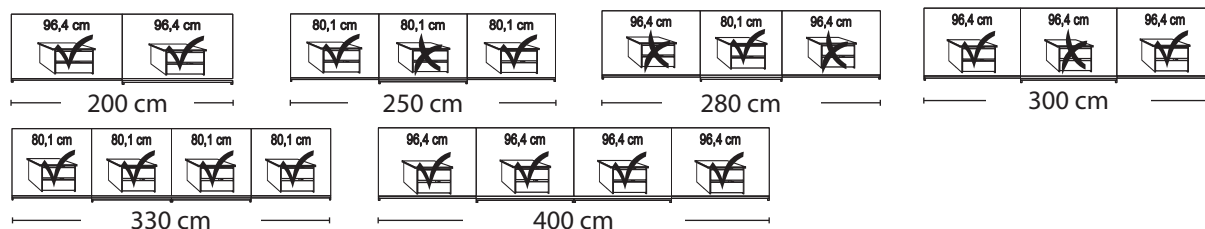

Kos.

Independent / non HDI

BLANK PRICE LISTvalid until **28.02.2025****V.i.P.**
by Wiemann**Sliding door wardrobes**

Handles in carcase colour

Interior:

2 adjustable shelves, 1 clothes rail

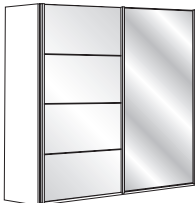
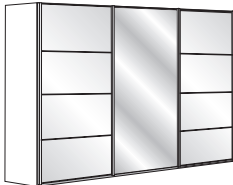
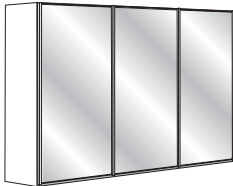
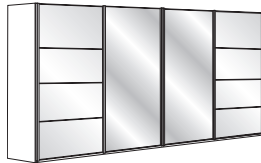
Description	Dimensions cm		Height 217 cm		Height 236 cm	
	W	D	Art. no.	GBP	Art. no.	GBP
Glass doors in white and crystal mirrored doors						
	2 doors	1 mirrored door left	200	67	540	553
	2 doors	1 mirrored door right	200	67	541	554
	2 doors	2 mirrored doors	200	67	542	555
	3 doors	1 centre mirrored door	250	67	543	556
	3 doors	3 mirrored doors	250	67	544	557
	3 doors	1 centre mirrored door	280	67	545	558
	3 doors	3 mirrored doors	280	67	546	559
	3 doors	1 centre mirrored door	300	67	547	560
	3 doors	3 mirrored doors	300	67	548	561
- with synchronous opening						
	4 doors	2 centre mirrored doors	330	67	549	562
	4 doors	4 mirrored doors	330	67	550	563
	4 doors	2 centre mirrored doors	400	67	551	564
	4 doors	4 mirrored doors	400	67	552	565

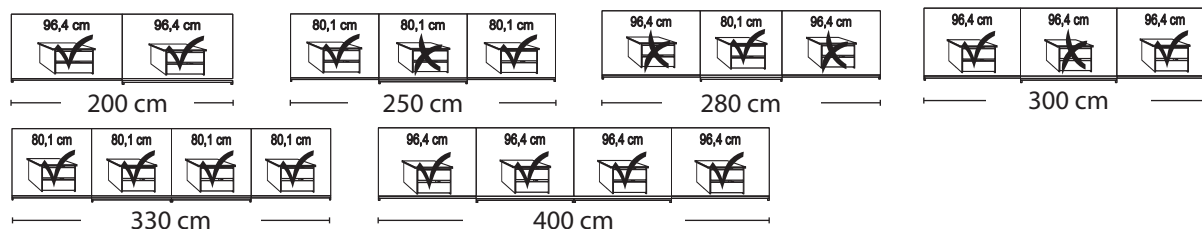
Plinth partition

Kos.

Independent / non HDI



BLANK PRICE LIST

valid until **28.02.2025**

V.i.P.
by Wiemann

Sliding door wardrobes
Handles in carcase colour

Interior:
2 adjustable shelves, 1 clothes rail

Description	Dimensions cm		Height 217 cm		Height 236 cm	
	W	D	Art. no.	GBP	Art. no.	GBP
Front in glass pebble grey						
	2 doors	200	67	566		572
	3 doors	250	67	567		573
	3 doors	280	67	568		574
	3 doors	300	67	569		575
- with synchronous opening						
	4 doors	330	67	570		576
	4 doors	400	67	571		577
						

Plinth partition

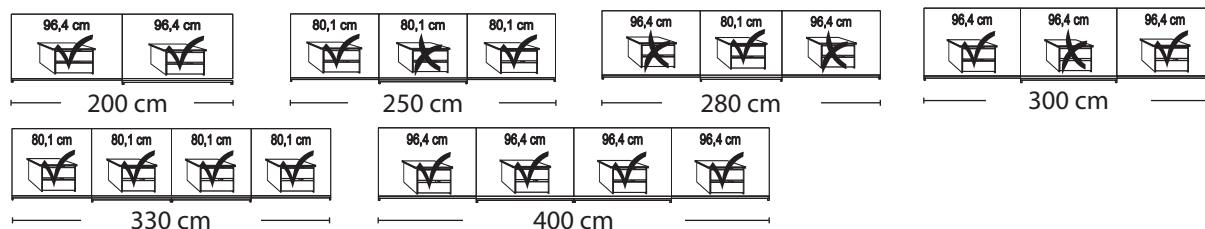

Kos.





Independent / non HDI

BLANK PRICE LISTvalid until **28.02.2025****V.i.P.**
by Wiemann**Sliding door wardrobes**



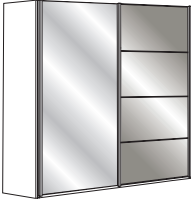
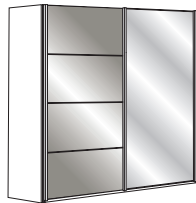

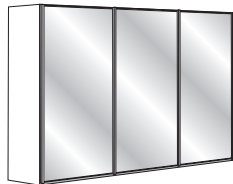
Handles in carcase colour

Interior:

2 adjustable shelves, 1 clothes rail

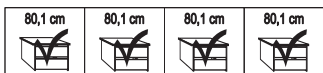
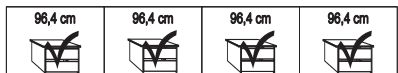

Description	Dimensions cm		Height 217 cm		Height 236 cm	
	W	D	Art. no.	GBP	Art. no.	GBP
 <p>Glass doors in pebble grey and crystal mirrored doors</p>	2 doors 1 mirrored door left	200	67	578		591
	2 doors 1 mirrored door right	200	67	579		592
	2 doors 2 mirrored doors	200	67	580		593
	3 doors 1 centre mirrored door	250	67	581		594
	3 doors 3 mirrored doors	250	67	582		595
	3 doors 1 centre mirrored door	280	67	583		596
	3 doors 3 mirrored doors	280	67	584		597
	3 doors 1 centre mirrored door	300	67	585		598
	3 doors 3 mirrored doors	300	67	586		599
 <p>- with synchronous opening</p>	4 doors 2 centre mirrored doors	330	67	587		600
	4 doors 4 mirrored doors	330	67	588		601
	4 doors 2 centre mirrored doors	400	67	589		602
	4 doors 4 mirrored doors	400	67	590		603

Plinth partition

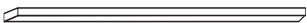
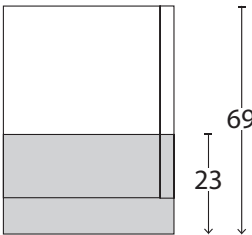

			
200 cm	250 cm	280 cm	300 cm
			
330 cm	400 cm		

Cornices for sliding-door wardrobes

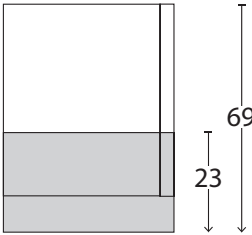
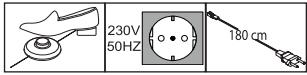
with or without lights

Description	Dimensions cm			Art. no.	GBP
	W	H	D		
 <p>Cornice, without lights</p> <p>- for width 200 cm - for width 250 cm - for width 280 cm - for width 300 cm - for width 330 cm - for width 400 cm</p> <p>Top view wardrobe incl. cornice</p>  <p>Dimensions cm</p>	200	5	23	677	
	250	5	23	678	
	280	5	23	679	
	300	5	23	680	
	330	5	23	681	
	400	5	23	682	
 <p>Cornice, with lights</p> <p>4 lights - for width 200 cm 6 lights - for width 250 cm 6 lights - for width 280 cm 6 lights - for width 300 cm 8 lights - for width 330 cm 8 lights - for width 400 cm</p> <p>Top view wardrobe incl. cornice</p>  <p>Dimensions cm</p> <p>This product contains light devices of energy efficiency class F</p> 	200	5	23	683	
	250	5	23	684	
	280	5	23	685	
	300	5	23	686	
	330	5	23	687	
	400	5	23	688	

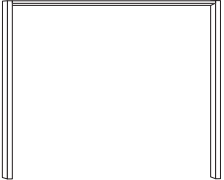
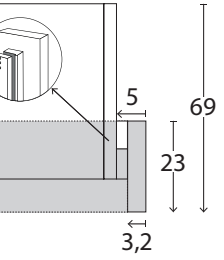
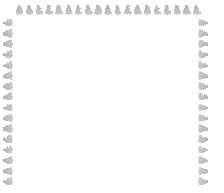
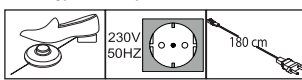
Passe-partout frames for sliding door wardrobes with or without lights

Description	Dimensions		Height 221 cm		Height 240 cm	
	W	D	Art. no.	GBP	Art. no.	GBP
 <p>Passe-partout frame, Width per side profile: 3.2 cm without lights</p> <ul style="list-style-type: none"> - for width 200 cm - for width 250 cm - for width 280 cm - for width 300 cm - for width 330 cm - for width 400 cm <p>Top view wardrobe incl. PPT-Frame</p>  <p>Dimensions cm</p>	210	23	701		710	
	260	23	703		712	
	290	23	704		713	
	310	23	705		714	
	340	23	707		716	
	410	23	708		717	
 <p>Surcharge for circumferential LED illumination (optional):</p> <ul style="list-style-type: none"> - for width 200 cm - for width 250 cm - for width 280 cm - for width 300 cm - for width 330 cm - for width 400 cm <p>This product contains light devices of energy efficiency class F</p> 	210	23	738		747	
	260	23	740		749	
	290	23	741		750	
	310	23	742		751	
	340	23	744		753	
	410	23	745		754	
 <p>Can not get assembled retrospectively!</p>						

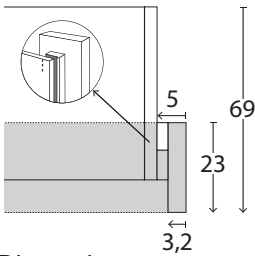
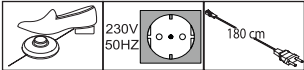

Passe-partout frames for sliding door wardrobes with lights

Description	Dimensions		Height 221 cm		Height 240 cm	
	W	D	Art. no.	GBP	Art. no.	GBP
 <p>Passe-partout frame, Width per side profile: 3.2 cm with lights</p> <p>4 lights - for width 200 cm 6 lights - for width 250 cm 6 lights - for width 280 cm 6 lights - for width 300 cm 8 lights - for width 330 cm 8 lights - for width 400 cm</p>	210	23	719		728	
	260	23	721		730	
	290	23	722		731	
	310	23	723		732	
	340	23	725		734	
	410	23	726		736	
<p>Top view wardrobe incl. PPT-Frame</p>  <p>Dimensions cm</p> <p>This product contains light devices of energy efficiency class F</p> 						





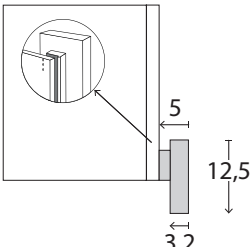

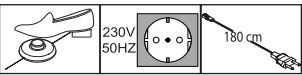
Kos.

Independent / non HDI







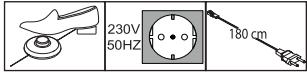

BLANK PRICE LISTvalid until **28.02.2025****V.i.P.**
by Wiemann**Additional elements**
for sliding door wardrobes

Description	Dimensions cm		Height 217 cm		Height 236 cm	
	W	D	Art. no.	GBP	Art. no.	GBP
 <p>Side profiles in carcass colour, pair</p> <p>Top view wardrobe incl. side profiles</p>  <p>Dimensions cm</p>	5	12,5	098		099	
 <p>Lights for side profiles</p> <p> Can not get assembled retrospectively! Useabl for side profiles and PPT-Frame without circumferential lights!</p> <p>This product contains light devices of energy efficiency class F</p> 	1,5	1	100		101	

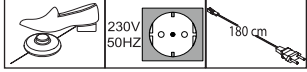
Unit accessories

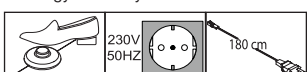
Description	Dimensions cm			Art. no.	GBP
	W	H	D		
 <p>Bumper</p> <p>- for 2-doors wardrobes 1 item</p> <p> Optimal functioning only in combination with self-closing mechanism for outer doors</p> <p>- for 3-4 door wardrobes 2 items</p> <p> Best performance in conjunction with soft closing mechanism!</p>	28	4	2	369	
 <p>Soft-closing mechanism for middle doors</p> <p>* - for 3-door units piece</p> <p>- for 4-door units piece</p> <p> * Please pay attention to clearance between wardrobe and ceiling! To be fitted from top of the wardrobe!</p>	24	2	11	363	
 <p>2-piece set self-closing mechanism with buffering for outer doors, Set for 2-,3- and 4-doors</p> <p>pair</p>	24	2	11	365	

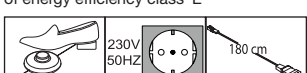
Unit accessories

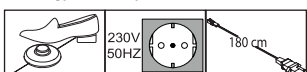
Description	Dimensions cm			Art. no.	GBP
	W	H	D		
 <p>LED Clip-On-Lights, silver</p> <p>This product contains light devices of energy efficiency class E</p>  <p>1 item 2 items 3 items</p> <p> Only in conjunction with PPT-Frame and cornice!</p>	60	1,5	4,5	980	
	60	1,5	4,5	981	
	60	1,5	4,5	982	
 <p>LED line light, silver</p> <p>This product contains light devices of energy efficiency class E</p>  <p>1 item 2 items 3 items</p>	60	6	19	983	
	60	6	19	984	
	60	6	19	985	
 <p>LED Clip-On-Lights, black</p> <p>This product contains light devices of energy efficiency class E</p>  <p>1 item 2 items 3 items</p> <p> Only in conjunction with PPT-Frame and cornice!</p>	60	1,5	4,5	880	
	60	1,5	4,5	881	
	60	1,5	4,5	882	
 <p>LED line light, black</p> <p>This product contains light devices of energy efficiency class E</p>  <p>1 item 2 items 3 items</p>	60	6	19	883	
	60	6	19	884	
	60	6	19	885	
 <p>LED top light, chrome</p> <p>This product contains light devices of energy efficiency class F</p>  <p>1 item 2 items 3 items</p>	5,5	3	22,5	970	
	5,5	3	22,5	971	
	5,5	3	22,5	972	

Kos.

Independent / non HDI

BLANK PRICE LISTvalid until **28.02.2025****V.i.P.**
by Wiemann**Unit accessories****Interior finish: silver grey striped**

When ordering more than one accessory item for a compartment, please make sure that all accessories do not interfere with each other's function.

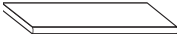
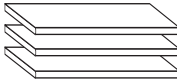
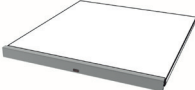
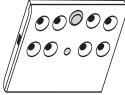

Description	Dimensions cm			Art. no.	GBP	
	W	H	D			
 <p>1 shelf</p> <p>- for compartment width 80.1 cm 1 item - for compartment width 96.4 cm 1 item</p>	80,1	2,2	51,5	032		
	96,4	2,2	51,5	030		
 <p>3 shelves</p> <p>- for compartment width 80.1 cm 3 items - for compartment width 96.4 cm 3 items</p>	80,1	2,2	51,5	033		
	96,4	2,2	51,5	031		
 <p>LED Light screen for shelves</p> <p>This product contains a light device of energy efficiency class F</p> <p>- for compartment width 80.1 cm piece - for compartment width 96.4 cm piece</p> <p>- for compartment width 80.1 cm 2 items - for compartment width 96.4 cm 2 items</p> <p>- for compartment width 80.1 cm 3 items - for compartment width 96.4 cm 3 items</p>	80,1	3	1	016		
	96,4	3	1	011		
	80,1	3	1	017		
	96,4	3	1	013		
	80,1	3	1	018		
	96,4	3	1	015		
 <p>LED Wardrobe interior lights with motion detector, incl. rechargeable battery via USB</p> <p>1 item 2 items 3 items 4 items</p>	10	2	10	006		
	10	2	10	007		
	10	2	10	008		
	10	2	10	009		

Kos.

Independent / non HDI

BLANK PRICE LISTvalid until **28.02.2025****V.i.P.**
by Wiemann**Unit accessories****Interior finish: silver grey striped**

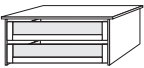
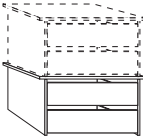
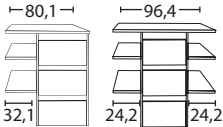
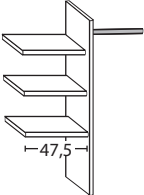
When ordering more than one accessory item for a compartment, please make sure that all accessories do not interfere with each other's function.

	Description	Dimensions cm			Art. no.	GBP
		W	H	D		
	Drawer insert with 2 drawers and glass front - for compartment width 80.1 cm - for compartment width 96.4 cm	80,1 96,4	41 41	52 52	069 070	
	Drawer insert with 2 drawers and wooden front, stackable and height adjustable - for compartment width 80.1 cm - for compartment width 96.4 cm	80,1 96,4	41 41	44 44	072 073	
	Drawer insert with 3 drawers and wooden front - for compartment width 80.1 cm - for compartment width 96.4 cm	80,1 96,4	89 89	51,5 51,5	024 064	
	Laundry shelf insert, consisting of: 3 adjustable shelves, 1 hanging rail, 1 mid panel - for compartment width 80.1 cm - for compartment width 96.4 cm	80,1 96,4	137 137	51,5 51,5	026 066	
	For use on both sides (left or right)! Only to be placed on base plinth!					

Kos.

Independent / non HDI
BLANK PRICE LIST
 valid until **28.02.2025**

V.i.P.
 by Wiemann

Unit accessories

When ordering more than one accessory item for a compartment, please make sure that all accessories do not interfere with each other's function.

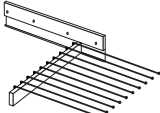
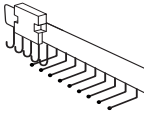
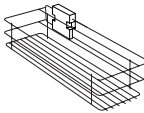
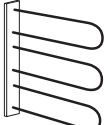
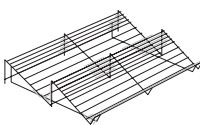

Description	Dimensions cm			Art. no.	GBP
	W	H	D		
 <p>Trousler holder</p>	45	10	50	056	
 <p>Tie and belt pull-out</p>	7	19	45	059	
 <p>Utensil pull-out</p>	16	9	45	076	
 <p>Tie and belt rack</p>	30	27	9	042	
 <p>Shoe rack for unit compartment W 96.4 cm</p>	96	15	50	094	

Kos.

Independent / non HDI

BLANK PRICE LISTvalid until **28.02.2025****V.i.P.**
by Wiemann**Unit accessories****Interior finish: silver grey striped**

When ordering more than one accessory item for a compartment, please make sure that all accessories do not interfere with each other's function.

Description	Dimensions cm			Art. no.	GBP
	W	H	D		
 <p>Clothes lift for compartment width 72.3 - 96.4 cm</p>	100	85	14	081	
 <p>Fold-out interior mirror</p> <p> Not for use in conjunction with LED light screens!</p>	36	173	2	080	

Kos.

Independent / non HDI



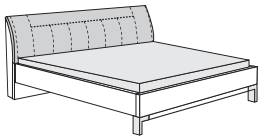
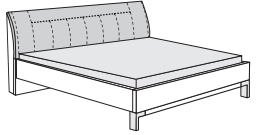

BLANK PRICE LISTvalid until **28.02.2025****V.i.P.**
by Wiemann**Futon beds**

Footboard height: 48 cm

4-position height adjustment

Description	Bed surface in cm	Surface in cm	Art. no.	GBP
 <p>Headboard cushion in faux leather white, Angled feet in silver</p> <p>Headboard height: 97 cm Footboard height: 48 cm Height to bed side top edge: 48 cm</p>	140 x 190	149 x 208	472	
	150 x 200	169 x 218	205	
	160 x 200	169 x 218	477	
	180 x 200	189 x 218	485	
 <p>Headboard cushion in faux leather pebble grey, Angled feet in silver</p> <p>Headboard height: 97 cm Footboard height: 48 cm Height to bed side top edge: 48 cm</p>	140 x 190	149 x 208	321	
	150 x 200	169 x 218	206	
	160 x 200	169 x 218	326	
	180 x 200	189 x 218	334	

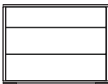
Bedside cabinets, 3 drawers

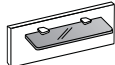
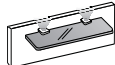
	Description	Dimensions cm			Art. no.	GBP	
		W	H	D			
	Bedside cabinet, 3 drawers						
	- Drawers glass white	piece	40	48	43	267	
		pair	40	48	43	268	
	Height 48 cm	piece	60	48	43	269	
		pair	60	48	43	270	
	- Drawers glass pebble grey	piece	40	48	43	271	
		pair	40	48	43	272	
		piece	60	48	43	273	
		pair	60	48	43	274	
	- Drawers glass white	piece	40	64	43	275	
		pair	40	64	43	276	
		piece	60	64	43	277	
		pair	60	64	43	278	
	Height 64 cm	- Drawers glass pebble grey	piece	40	64	43	279
			pair	40	64	43	280
		piece	60	64	43	281	
		pair	60	64	43	282	
	Beside cabinet panel, with smoked glass shelf						
		piece	40	20	12	300	
		pair	40	20	12	301	
		piece	60	20	12	302	
		pair	60	20	12	303	
	Bedside cabinet panel with smoked glass shelf and LED-lights						
		piece	40	20	12	112	
		pair	40	20	12	113	
		piece	60	20	12	114	
		pair	60	20	12	115	
	This product contains light devices of energy efficiency class G						

Kos.



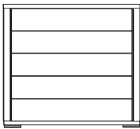
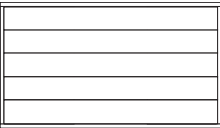
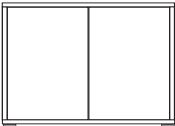
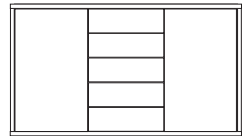

Independent / non HDI

BLANK PRICE LISTvalid until **28.02.2025****V.i.P.**
by Wiemann**Chests of drawers, 86 cm high**
incl. sliding feet

All hinged-doors incl. cushioned hinges

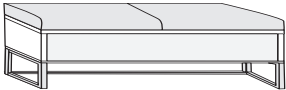
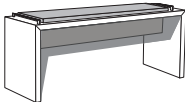
	Description	Dimensions cm			Art. no.	GBP
		W	H	D		
	Chest of drawers with 5 drawers					
	- Front glass white	60	86	43	871	
	- Front glass pebble grey	60	86	43	872	
	- Front glass white	80	86	43	869	
	- Front glass pebble grey	80	86	43	870	
	- Front glass white	141	86	43	873	
	- Front glass pebble grey	141	86	43	874	
	Dresser, 2 doors, with one full-width shelf					
	- Front glass white	80	86	43	909	
	- Front glass pebble grey	80	86	43	911	
	Combi dresser with 5 drawers and 2 doors					
	- Front glass white	141	86	43	920	
	- Front glass pebble grey	141	86	43	921	

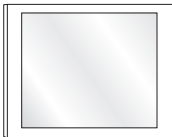
Occasional furniture

	Description	Dimensions cm			Art. no.	GBP
		W	H	D		
	Dressing bench on angled feet in silver and one drawer with upholstered cushion					
	in faux leather white					
	- Front glass white	141	50	43	157	
	- Front glass pebble grey	141	50	43	089	
	in faux leather pebble grey					
	- Front glass white	141	50	43	171	
- Front glass pebble grey	141	50	43	172		
	Dressing bench with upholstered faux leather cushion					
	- with faux leather white	120	53	40	176	
	- with faux leather pebble grey	120	53	40	111	
	 Not available in havana finish!					
	Wall mirror , lateral or vertical mounting					
		110	85	3	086	
	Wall mirror					
		60	80	3	087	